

High Power Laser Diode 4-Pin Fiber Module

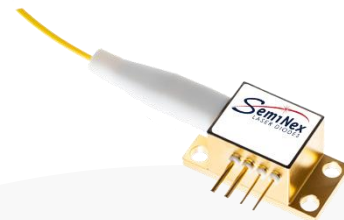

Part Number: 4PN-116

High Power 4-Pin Fiber Coupled Module
Multi-Mode Fabry-Perot Laser Diode
CW Wavelength at 1320nm



Features

- High Output Power
- High Dynamic Range
- High Efficiency
- 4-Pin Fiber Coupled Module
- Cost Effective

Application

- Professional Medical
- Aerospace



SemiNex delivers the highest available power at infrared wavelengths between 12xx and 19xx nm. When necessary, we will further optimize the design of our InP & GaSb laser chips to meet our customers' specific optical and electrical performance needs. Diodes, bars and packages are tested to meet customer and market performance demands. Typical results and packaging options are shown. Contact SemiNex for additional details or to discuss your specific requirements.

SemiNex Corporation • 153 Andover Street, Suite 201, Danvers, MA 01923 • 978-326-7700 • sales@seminex.com

High Power Laser Diode 4-Pin Fiber Module



Specification

4PN-116

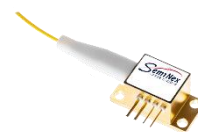

Optical	Symbol	Typ.	Units
Center Wavelength	λ_c	1320	nm (± 20)
Output Power (CW)*	P_{out}	4.5	watts ($\pm 10\%$)
Spectral Width FWHM	$\Delta\lambda$	10	nm
Slope Efficiency	η	0.44	W/A
Optical Fiber Core Dia.		105	μm
Optical Fiber NA		0.22	
Electrical	Symbol		Units
Power Conversion Eff.	η	20	%
Operating Current	I_{op}	13	A
Threshold Current	I_{TH}	0.5	A
Operating Voltage	V_{op}	1.7	V
Mechanical	Symbol		Units
Fiber Length		1.5	meters
Connector Type		SMA905	
Thermistor Constant		3477	β
Thermistor Resistance		10	K ohm
		Range	
Operating Temp.**		-40 to 60	$^{\circ}\text{C}$
Storage Temp.		-40 to 80	$^{\circ}\text{C}$

PLEASE NOTE: The 4 Pin laser package is not electrically isolated. The package body is the anode connection. Care should be taken in mounting and installation.
 *Specified values are rated at a constant heat sink temperature of 20°C.
 **High temperature operation will reduce performance and MTF.
 Unless otherwise indicated all values are nominal.

WARNING - FIBER HANDLING

- Do NOT bend the fiber tighter than 26 mm radius during installation or handling.
- Do NOT bend the fiber tighter than 52 mm radius during normal operation or long-term use
- Exceeding these limits may cause permanent fiber damage and increased optical loss

SemiNex Corporation • 153 Andover Street, Suite 201, Danvers, MA 01923 • 978-326-7700 • sales@seminex.com

High Power Laser Diode 4-Pin Fiber Module



SemiNex Laser Diodes 4PN-116

Graphs & Data

Typical 4PN L-I-V Characteristics

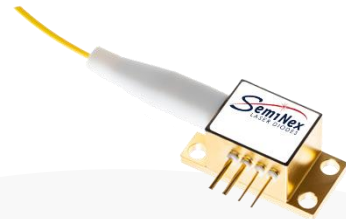
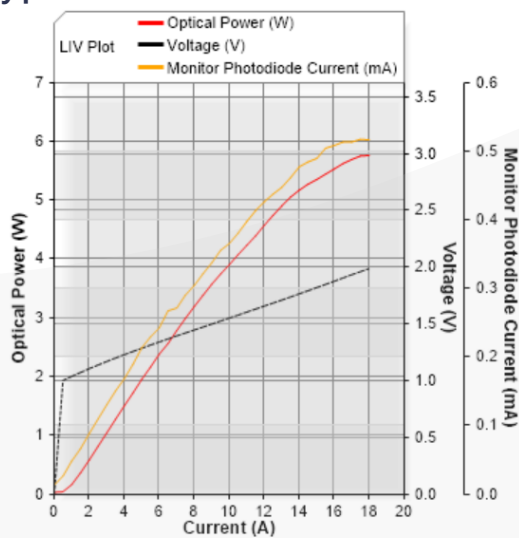

Typical 4PN Output Spectrum

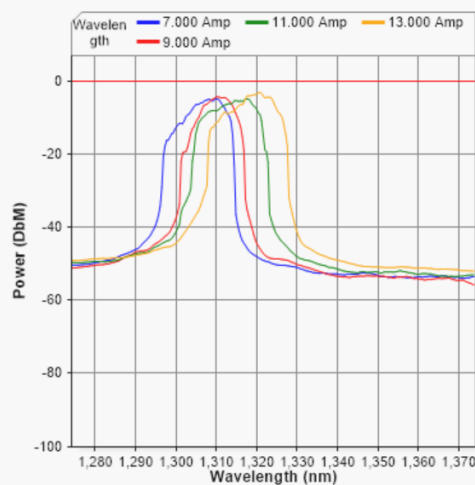

High Power Laser Diode 4-Pin Fiber Module



Mechanical Drawing

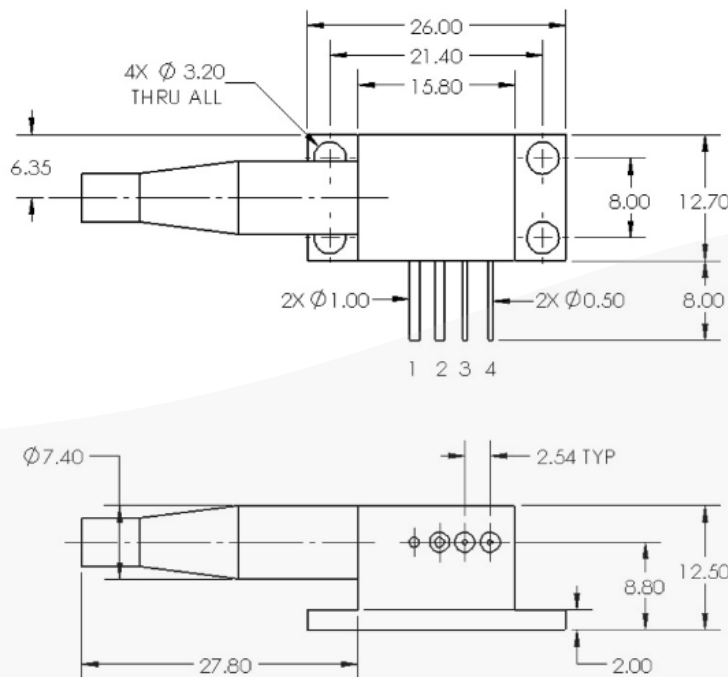
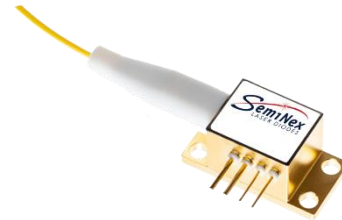

Pins	Function
1	LD Anode (+)
2	LD Cathode (-)
3	PD (-) or Thermistor
4	PD (+) or Thermistor

All statements, technical information and recommendations related to the product herein are based upon information believed to be reliable or accurate. The accuracy or completeness herein is not guaranteed, and no responsibility is assumed for any inaccuracies. The user assumes all risks and liability whatsoever in connection with the use of a product or its application. SemiNex Corporation reserves the right to change at any time without notice the design, specification, deduction, fit or form of its described herein, including withdrawal at any time of a product offered for sale herein. Users are encouraged to visit www.seminex.com for the latest data. SemiNex Corporation makes no representations that the products herein are free from any intellectual property claims of others. Please contact SemiNex for more information. 2024 SemiNex Corporation



SemiNex Corporation • 153 Andover Street, Suite 201, Danvers, MA 01923 • 978-326-7700 • sales@seminex.com