

High Power External Cavity Laser 14-pin Butterfly Narrow Linewidth Single-Frequency

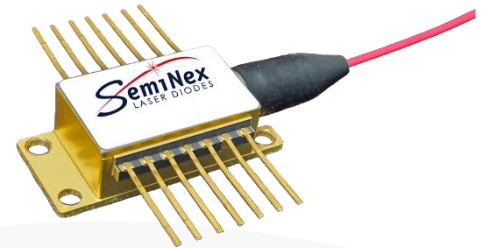

Part Number: 14BF-310-200

High Power External Cavity Laser
14BF Narrow Linewidth Single-Frequency
CW Wavelength at C band



Features

- Narrow linewidth (< 15kHz)
- Wavelength ranges cover C-band wavelengths
- High output optical power (up to 200mW)
- Ultra-low RIN, excellent SMSR
- SemiNex RSOA and SOA Chip Inside

Application

- Fiber optical sensing: acoustic & seismic interferometric sensing, Oil & Gas - exploration and production
- LiDAR and industrial metrology
- Optical measurements and instrumentation



SemiNex delivers the highest available power at infrared wavelengths between 12xx and 19xx nm. When necessary, we will further optimize the design of our InP & GaSb laser chips to meet our customers' specific optical and electrical performance needs. Diodes, bars and packages are tested to meet customer and market performance demands. Typical results and packaging options are shown. Contact SemiNex for additional details or to discuss your specific requirements.

SemiNex Corporation • 153 Andover Street, Suite 201, Danvers, MA 01923 • 978-326-7700 • sales@seminex.com

High Power External Cavity Laser 14-pin Butterfly Narrow Linewidth Single-Frequency



Specification

14BF-310-200

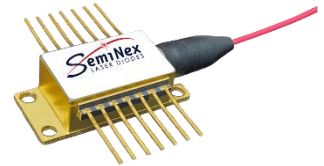

Optical	Symbol	Min.	Typ.	Max.	Units
Center Wavelength	λ_c		1550 or C band		nm
Linewidth (Lorentzian)	FWHM		10	15	kHz
Fiber Output Power	P_f		200		mW
Side Mode Suppression	SMSR		60		dB
Polarization Extinction Ratio	PER	20			dB
Random Intensity Noise	RIN			-145	dB/Hz
Optical Isolation	ISO		50		dB
Operating Temperature	T _O	-20		60	°C
Storage Temperature	T _S	-40		85	°C
Operating Humidity	%	5		85	
Parameter	Symbol	Min.	Typ.	Max.	Unit
LD Voltage	V _{LD}		1.6	1.8	V
LD Current	I _{LD}		150	300	mA
TEC Voltage	V _{TEC}		1.8	2.5	V
TEC Current	I _{TEC}		1	1.5	A
TEC Temp.	T _{TEC}		25	50	°C
SOA Voltage	V _{SOA}		2		V
SOA Current	I _{SOA}		1000		mA

*Specified values are rated at a constant heat sink temperature of 20°C.

**High temperature operation will reduce performance and MTTF.

Unless otherwise indicated all values are nominal.

WARNING - FIBER HANDLING

- Do NOT bend the fiber tighter than 26 mm radius during installation or handling.
- Do NOT bend the fiber tighter than 52 mm radius during normal operation or long-term use.
- Exceeding these limits may cause permanent fiber damage and increased optical loss.

High Power External Cavity Laser 14-pin Butterfly Narrow Linewidth Single-Frequency



SemiNex Laser Diodes 14BF-310-200 Graphs & Data

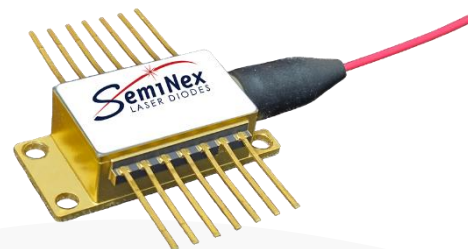

Lorentzian Linewidth (11.6kHz)

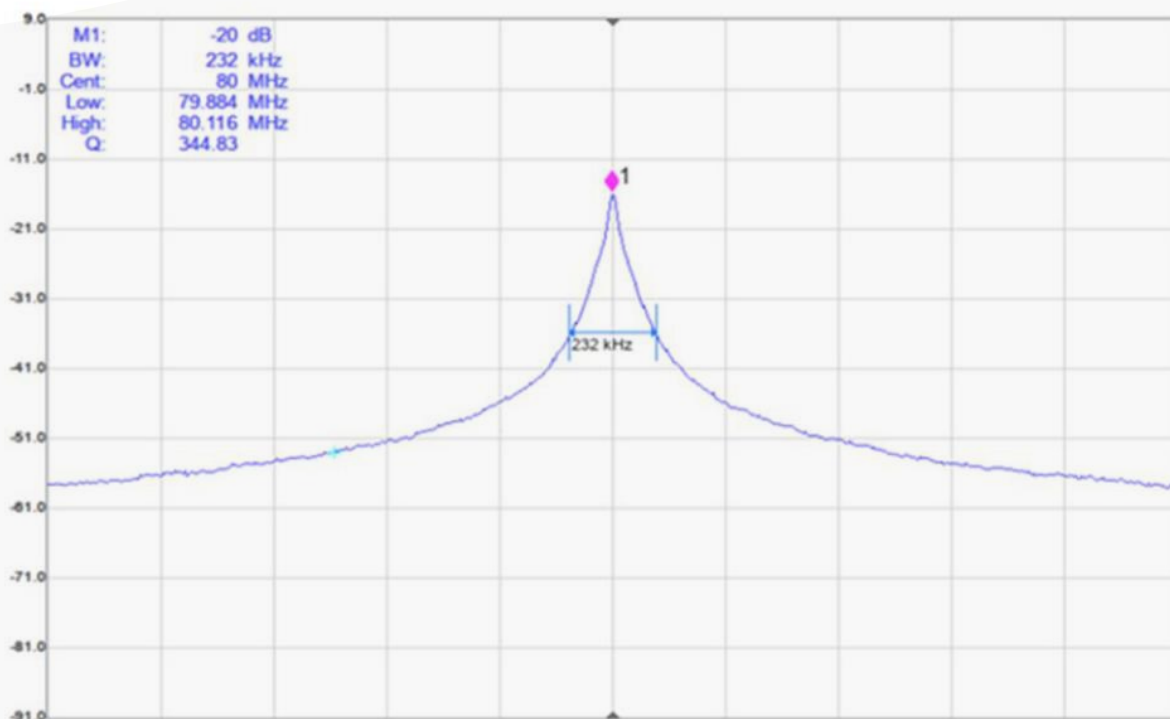

High Power External Cavity Laser 14-pin Butterfly Narrow Linewidth Single-Frequency



Mechanical Drawing

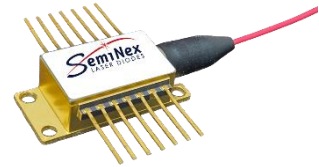

No.	Description	Parameter	Unit	Note
1	Fiber type	PMF ϕ 0.9mm red		PMF/SMF Optional
2	Fiber length	1000 \pm 10	mm	
3	Connector	FC/APC		

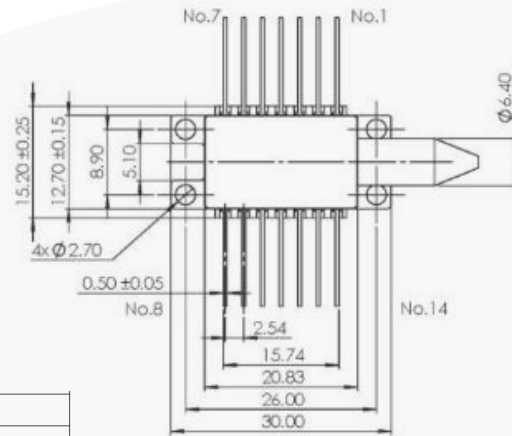
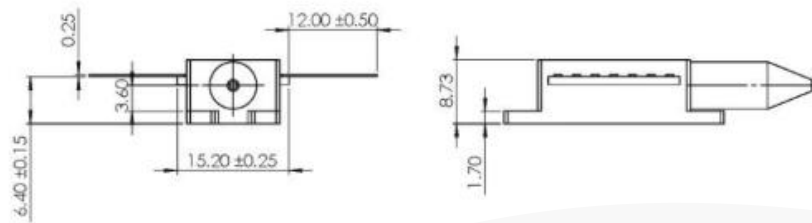

Pinout				
1	TEC +	8	N/A	
2	NTC	9	N/A	
3	NTC	10	N/A	
4	N/A	11	SOA+	
5	LD+	12	SOA-	
6	LD-	13	Case	
7	N/A	14	TEC -	

Warnings:
Make sure to wear protective goggles while operating high power laser that could be harmful to eyes. Nearby operators should wear protective goggles to avoid harms from the reflective of the laser. SemiNex reserves the right to modify this document without notice.

All statements, technical information and recommendations related to the product herein are based upon information believed to be reliable or accurate. The accuracy or completeness herein is not guaranteed, and no responsibility is assumed for any inaccuracies. The user assumes all risks and liability whatsoever in connection with the use of a product or its application. SemiNex Corporation reserves the right to change at any time without notice the design, specification, deduction, fit or form of its described herein, including withdrawal at any time of a product offered for sale herein. Users are encouraged to visit www.seminex.com for the latest data. SemiNex Corporation makes no representations that the products herein are free from any intellectual property claims of others. Please contact SemiNex for more information. 2024 SemiNex Corporation



SemiNex Corporation • 153 Andover Street, Suite 201, Danvers, MA 01923 • 978-326-7700 • sales@seminex.com