

OtO Photonics

Merak Series Product Sheet



Introduction

Merak (MR) series spectrometers combine a 4096-pixel CMOS sensor and 32-bit RISC controller with a new fully transmissive T-T-T Czerny-Turner optical cavity design to deliver high resolution, high sensitivity, low dispersion and high-speed spectral response.

Merak's patented alignment mechanism delivers optimum (0.1nm) optical resolution for the needs of high-resolution, high-sensitivity measurements.

Featuring an improved body and built-in LED indicators, communication and power is via USB with the addition of six I/O pins for connecting external devices.

The MR series 32-bit RISC controller can be operated using OtO Photonics' SpectraSmart software, which includes a Windows SDK and example code for interface protocols.



This document is intended for sales and marketing purposes only and may not serve as a specification document for shipping or contracts. If a specification for product approval or IQC is required please contact OtO or your distributor.

MR Series-502 Rev.2
www.otophotonics.com

Precautions

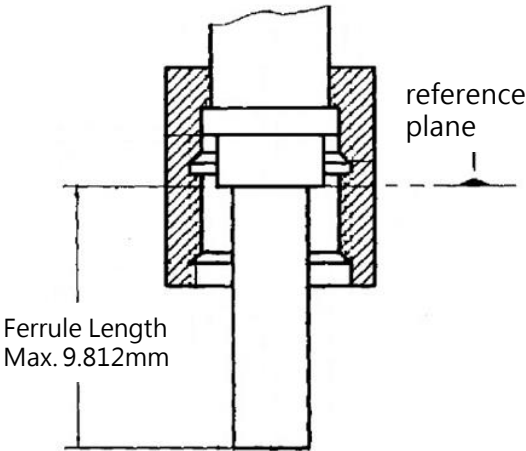
Picture	Description
	<p>Screw in the fiber optic connector with fingers. Do not use any tool to tighten it. Using tools such as wrenches to tighten the connector may cause the connector to press against and damage the inlet slit of the spectrometer. Such damage is not covered by the warranty.</p> <p>In cases where the connector needs to be firmly in place for long-term use, it is advised to apply a little glue to where the SMA905 connector is connected to the spectrometer.</p>
	<p>The SMA905 connectors on all spectrometers made by OtO Photonics is manufactured in accordance with international standards. Customers should ensure that the ferrule length of the fiber used is not longer than 9.812mm to avoid damaging the slit in the SMA950 connector. Such damage is not covered by the warranty.</p>

■	Overview	
1.1	MR Series Products	P4
1.2	Response Curves	P5
■	Key Features	
2.1	Characteristics	P6
2.2	Features	P7
■	Mechanical Designs	
3.1	Outlines and Dimensions	P8
3.2	Electronic Output Pin Assignments	P9
3.3	LED Indicators	P10
3.4	Sensor Overview	P11
■	Operations	
4.1	Pixel Signal Intensity	P12
4.2	Digital Input/Output	P12
4.3	Trigger Modes	P14
4.4	Ring Buffer	P17
■	USB Data Transfer and Controls	P18

Overview

1.1 MR Series Products

Model	Wavelength range (nm)	SNR	Dynamic range ^{*1}	A/D	Stray Light	Thermal Stability Test
	NIRT2					
	830 ~ 970					
MR1080	√	350	3700	16 bits	N/A	<0.007nm/°C

*1. The dynamic range is calculated using the average dark noise value of multiple spectrometers.

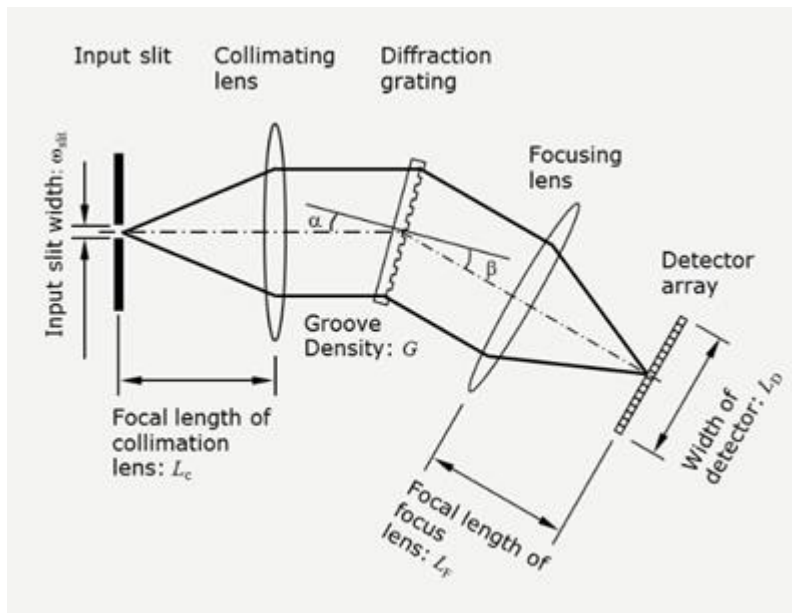
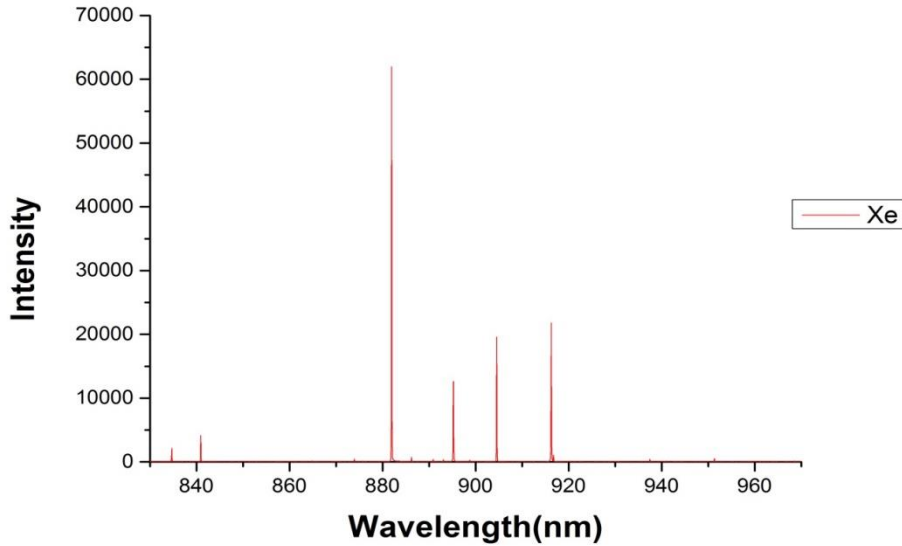

Fig. 1 : T-T-T fully transmissive Czerny-Turner optical design

► 1.2 Response Curves



Wavelength	840.918	881.941	895.225	904.544	916.265	937.476
Resolution	0.088	0.089	0.103	0.079	0.107	0.081

Figure 2. MR1080 Series xenon lamp wavelength resolutions

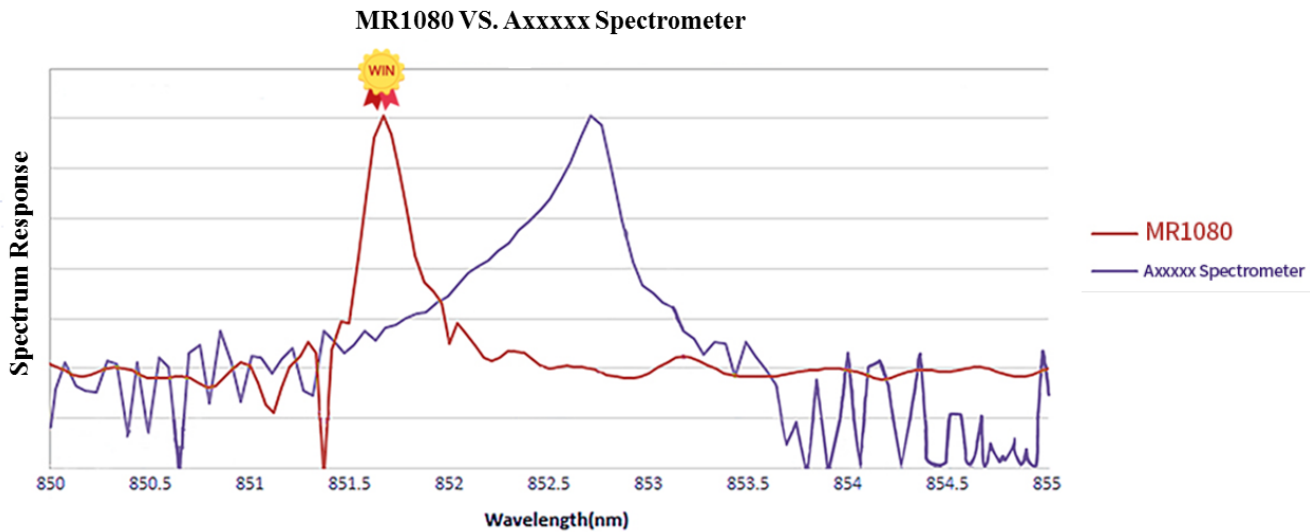

Figure 3. VCSEL spectrum response_MR1080 VS Axxxxx Spectrometer

■ Key Features

▶ 2.1 Characteristics

- Wavelength range: 830-970nm, with resolution <0.1nm at 850nm and 940nm
- Sensor:
 - ▣ High speed 4096-pixel CMOS sensor
- Customizable modular components: grating, sensor, and inlet slit
- Integration time: 100µs-65sec
- 16 bit, 15MHz A/D converter
- USB 2.0 @ 480 Mbps (High Speed)
- An 8-pin external I/O port (with a built-in LED indicator) for connecting external devices
 - ▣ 6 pins for digital I/O data acquisition
- Plug-n-Play computer application support
- Ultra-precise continuous exposure, holding up to 4,000 records of spectrum data in memory
- Sensor clock frequency: 2.5MHz
- Flash ROM storage
 - ▣ Wavelength calibration parameters
 - ▣ Linearity correction parameters
 - ▣ Intensity correction parameters

OtO Photonics

Merak Series Product Sheet

► 2.2 Specifications

Features		Specifications
		MR1080
Sensor	4096-pixel CMOS	
Dark noise (max)	18	
Dynamic range	3700	
SNR	350	
Wavelength range	830 - 970 nm	
Optical system characteristics	f/#: 5, NA: 0.1 Effective focal length (L1-L2): 85-89mm @840nm	
Optical design	Czerny-Turner optical design, 2nd and 3rd harmonics removed	
Dimensions	230 (L) x 170 (W) x 60 (H) mm	
Grating	1500g / 930nm	
Slit width	5 μ m	
Integration time	420 μ s-65 sec	
Resolution (FWHM)	0.07 ~ 0.11 nm (Resolution at 850nm and 940nm: <0.1nm)	
Fiber optic interface	SMA905 or FC/PC	
Environmental requirements	Storage temperature	-30°C to +70°C
	Operating temperature	0°C to +50°C
	Relative Humidity	0% - 90% non-condensing
Data transfer interface	USB 2.0	
Power specifications	Power supply: 300mA at +5 VDC Voltage: 4.75-5.25 Boot up time: < 4s USB maximum input Vcc: +5.25VDC I/O signal voltage: +5.5VDC	

Mechanical Designs

3.1 Outlines and Dimensions

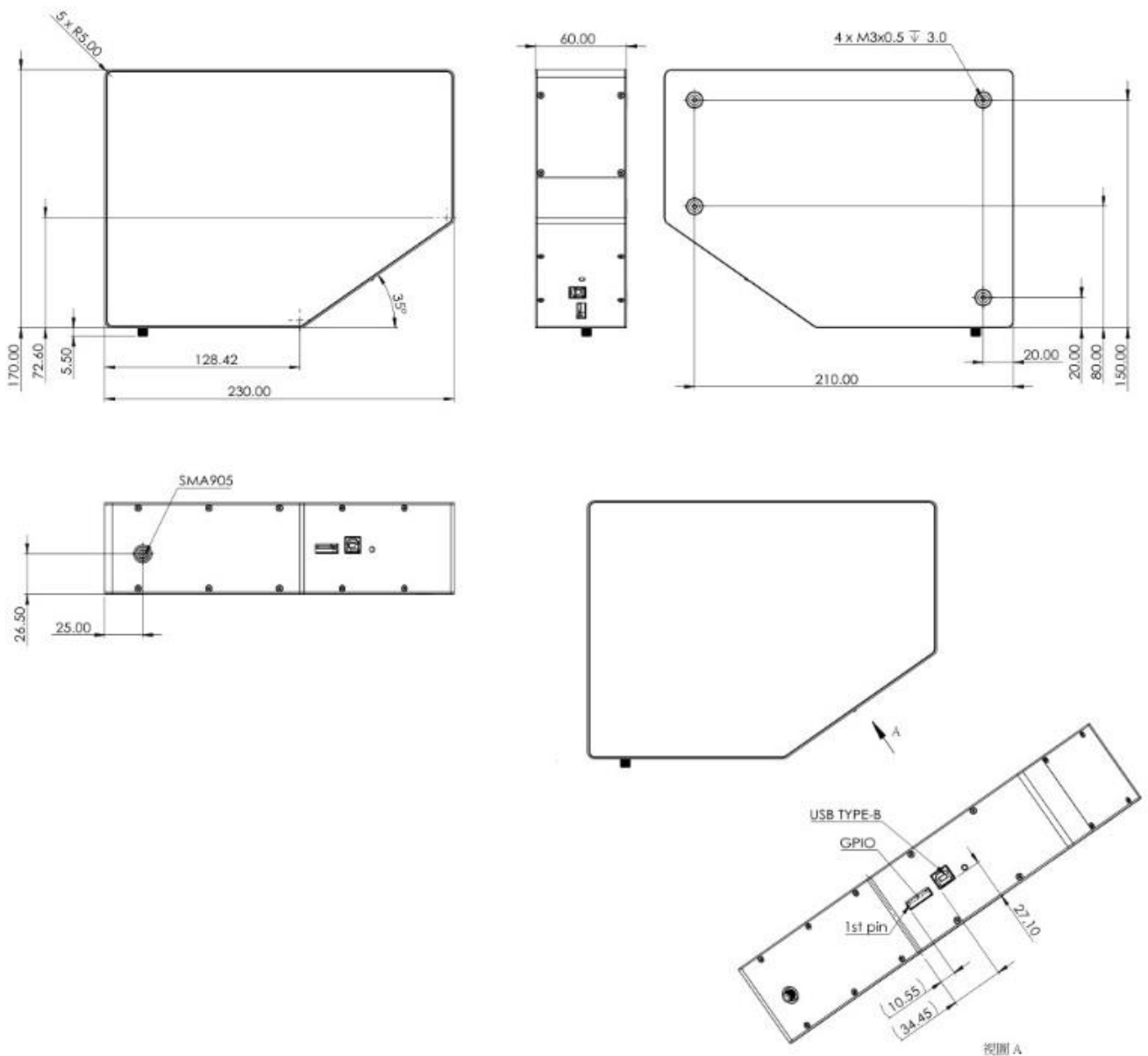

Figure 4. MR1080 outlines and dimensions

OtO Photonics

Merak Series Product Sheet

► 3.2 Electronic Output Pin Assignments

The MR Series provides an 8-pin 2.0mm rear external I/O port.

Side entry type

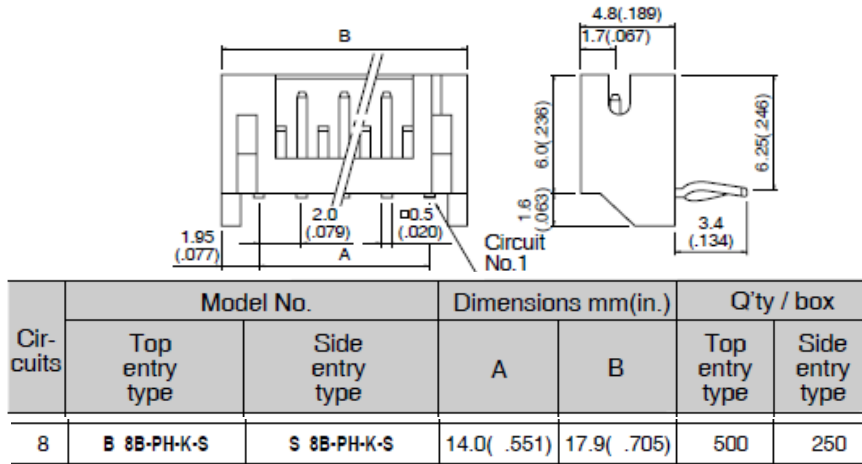

Figure 5. The 8-pin 2.0 mm rear external I/O port

● Pin Assignments on the External I/O Port

Pin #	Type	Name	Description
1	Power	5V Input/Output	When the spectrometer is connected via USB to a computer, this pin connects to the VBUS so that the spectrometer can provide 0.1A of power to the external device.
2	Output	TX	UART TX. TX is the output from the RISC microcontroller.
3	Input	RX	UART RX. RX is the input to the RISC microcontroller.
4	Output	GPIO0	General purpose output #0.
5	Output	GPIO1	General purpose output #1.
6	Output	LS_ON	Lamp on.
7	Input	Trigger_IN	External trigger signal.
8	GND	GND	Ground.

● External Ports

The following figure shows the external ports on the MR Series. From left to right: the rear external I/O port, the PC USB port, and the LED indicator.

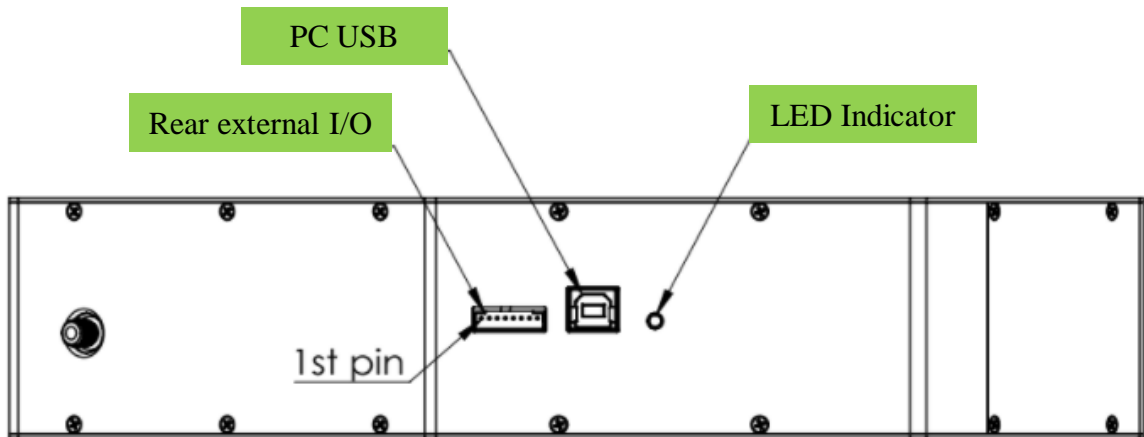

Figure 6. External ports on the MR Series

► 3.3 LED Indicator

The MR Series comes with an LED indicator, which indicates one of the three states described below:

- Green light: When connecting via USB port to a PC, the light is steadily on when power is supplied.
- Orange light: When the spectrometer is sending data back to the host (PC), the orange light flashes during the data transmission.

Note: The light does not flash when the host (PC) sends commands to the spectrometer.

- Light off: This means no power is supplied to the spectrometer.

▶ 3.4 Sensor Overview

● Sensor / System Noise

The three key factors that affect the noise level of the output signal are: stability of the light source, electronic noise, and the sensor noise. Excluding the effect of the external light source, the first thing to check is the dark noise of the measurement system. Dark noise is defined as the voltage output (V_{out} RMS) over a period of 10ms integration time in a completely dark environment. So the dark noise level is solely determined by the electronic noise in the readout and the CCD/CMOS sensor itself.

Another way to determine the quality of the signal is signal-to-noise ratio (SNR). SNR is defined as the maximum signal level (65535) divided by RMS. Higher SNR means the signal is cleaner, and differences between signals are more discernible when signal levels are low.

● Signal Averaging

In general, there are two ways to obtain a smooth curve for a signal: signal averaging and boxcar filter. Signal averaging can reduce the influence of noise on individual pixels. It is natural that increasing the number of samples taken for averaging creates a better averaged curve, but then it takes more time get the final spectrum. On the time-based curve, the signal-to-noise ratio (SNR) increases in proportion to the square root of the number of samples taken. For example, if the number of samples taken is 100, the SNR is increased 10 times.

The second method, boxcar filter, uses neighboring pixels for averaging to get a smooth curve for the signal, but it negatively impacts the optical resolution. This method is not recommended if you need to find the peak values of the signal. These two methods can be combined together in a single measurement if required.

■ Operations

▶ 4.1 Pixel Signal Intensity

The spectrometer is shipped with a baseline signal intensity at 1,000 counts. In cases where the user needs to modify this baseline intensity, it can be done using control commands. There is a command for the user to adjust the AFE OFFSET. Another way to change the baseline signal intensity is to use the "background removal" feature in the software. Which one to use depends on the way the user wants to use the baseline signal intensity.

▶ 4.2 Digital Input/Output

General purpose input/output (GPIO)

The MR Series comes with six 3.3V digital input/output pins that can be used for data acquisition on the 8-pin external I/O port. Using software, these I/O pins can be defined for different application purposes. To support some OEM customization needs, the MR Series provides the flexibility to use a special clock generator (such as single pulse or PWM).

GPIO recommended voltages:

$V_{IL(max)} = 0.8V$

$V_{IH(min)} = 2.0V$

GPIO maximum/minimum voltages:

$V_{IN(min)} = -0.3V$

$V_{IN(max)} = 5.5V$

- **Data transfer interface**

USB 2.0

The 480Mbit/s USB (Universal Serial Bus) is a widely used data transfer standard for computers. The spectrometer control software provided by OtO Photonics uses USB to connect to multiple MR Series spectrometers. The energy-saving MR Series can be powered via a USB cable over its VBUS line.

- **Ultra-precise continuous exposure**

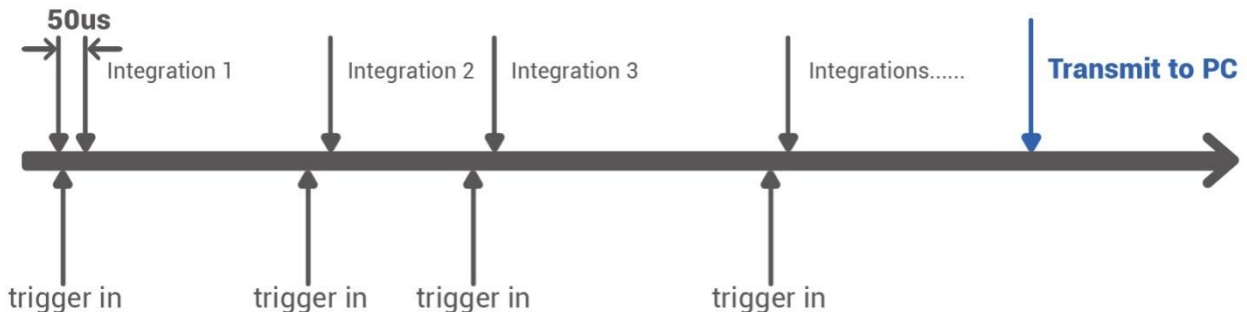

- ❑ Configurable arbitrary integration time
- ❑ The spectrum being captured is stored in the memory. The memory can hold up to 4,000 records of spectrum data
- ❑ The captured spectrum data is transferred to the host computer all at once when the measure is complete

► 4.3 Trigger Modes

- **Single trigger/single capture**

In the single trigger/single capture mode (with preconfigured integration time), the spectrometer waits for a trigger pulse and captures the spectrum once upon receiving the trigger pulse. It can be triggered on a rising edge or a falling edge. An integration time programming delay can also be configured.

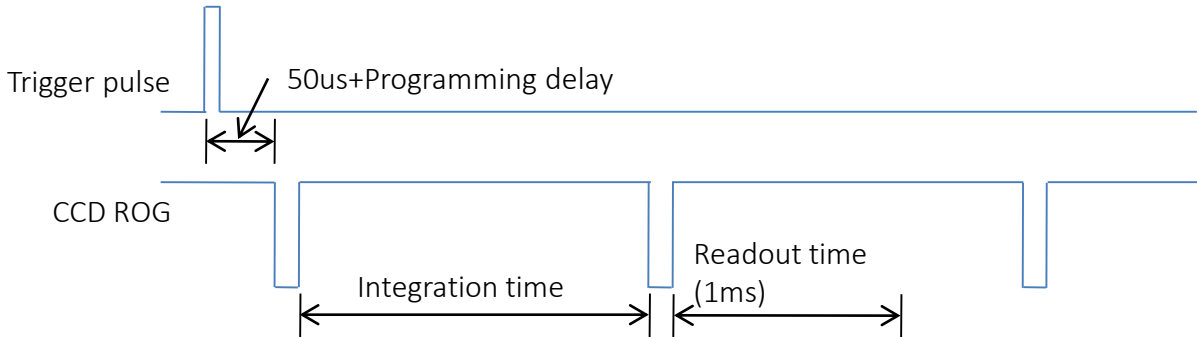

- **Single trigger/multiple capture**

In the single trigger/multiple capture mode (with preconfigured integration time and the number of captures to be made), the spectrometer captures the specified number of consecutive spectrums upon receiving the trigger pulse.

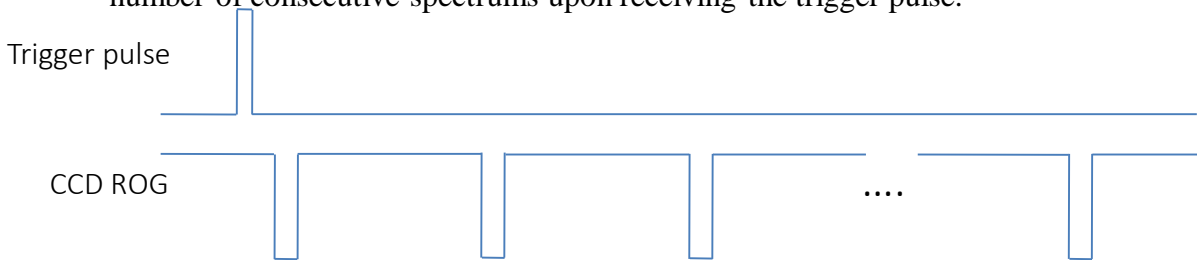

- **Multiple trigger/multiple capture**

In the multiple trigger/multiple capture mode (with preconfigured number of triggers and integration time for each trigger), the spectrometer captures a spectrum upon each trigger with the specified integration time for that trigger.

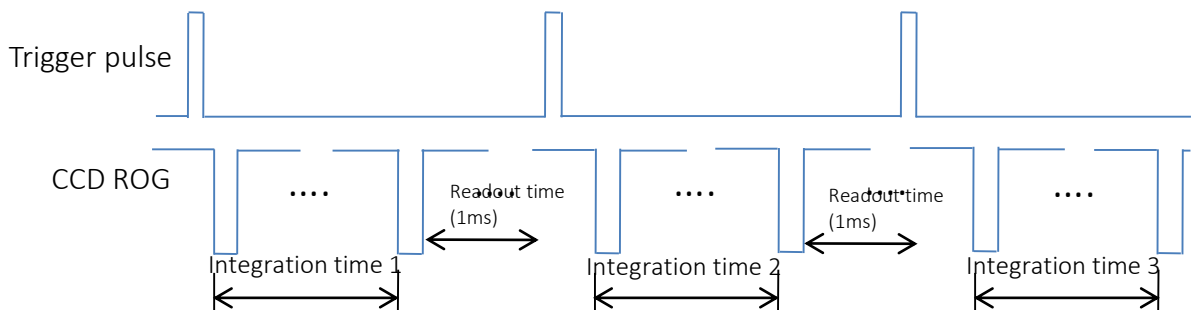

- **Software trigger**

In the software trigger mode (with preconfigured integration time), the spectrometer waits for the external trigger signal level to go up then starts and continues to capture the spectrum using preconfigured integration time till the signal level drops.

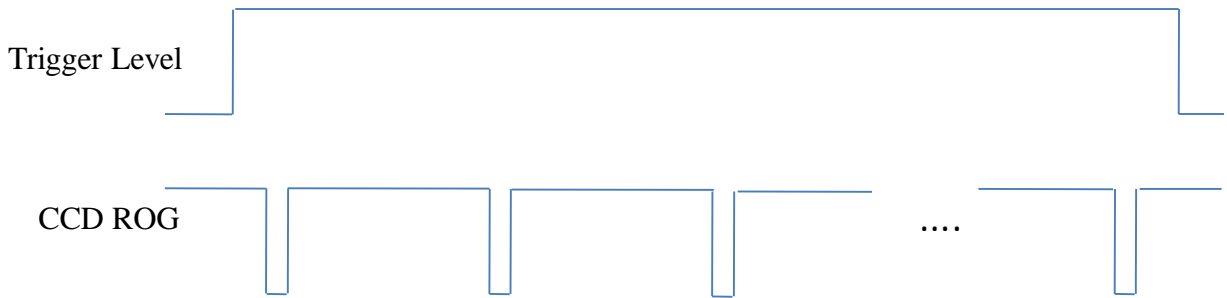

- **Software trigger/multiple capture**

In the software trigger/multiple capture mode (with preconfigured integration time and software commands to capture the spectrum), the spectrometer continues to capture the spectrum with the preconfigured integration time even when the trigger pulse drops.

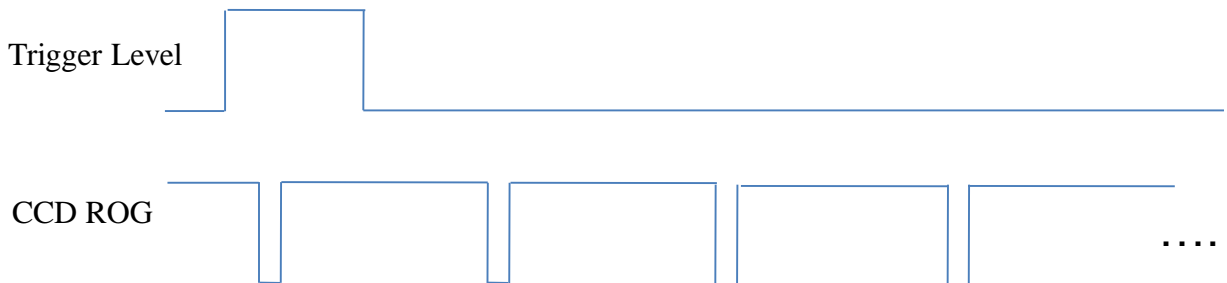

- **External trigger full control**

In the external trigger full control mode, the MR Series allows the external trigger signal to control the integration time. As show in the following picture, the integration time ends upon the rising edge of the external trigger signal. In other words, each individual integration time is totally up to the control of the external signal. This feature is provided by OtO Photonics per customer request. When using a spectrometer supporting this mode, the user can configure the spectrometer via the USB connection. In this mode, the integration time equals to the interval between two triggers.

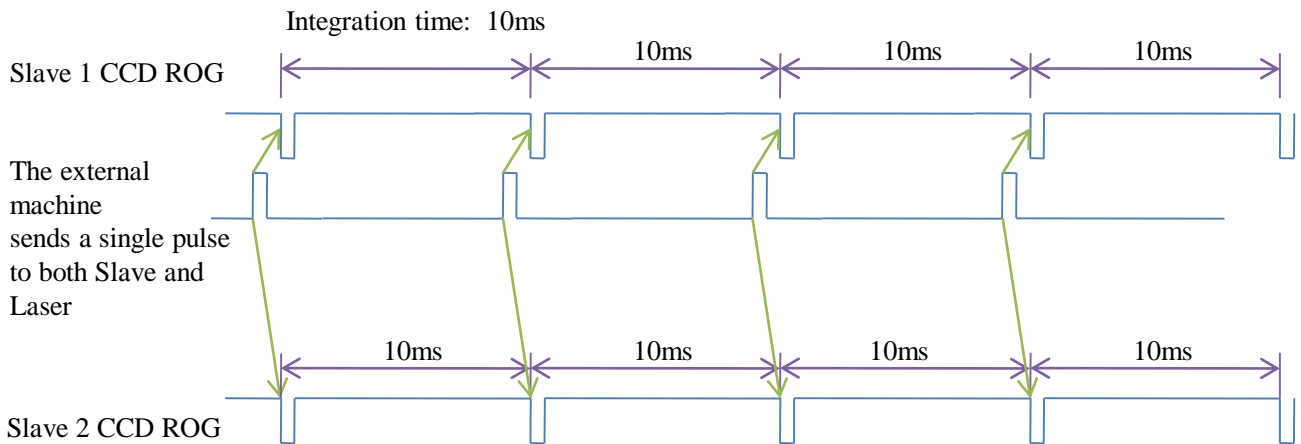

OtO Photonics

Merak Series Product Sheet

► 4.4 Ring Buffer

The MR Series supports a ring buffer mode for continuous spectrum capture. This feature is provided by OtO Photonics per customer request. The ring buffer enables the user to record continuous spectrum data. For example, a computer can be set up to receive 360,000 records of spectrum data within 1 hour (with an integration time at 10ms). In the ring buffer mode, the computer can control the size of each data transfer for efficient use of USB bandwidth. The ring buffer helps mitigate data congestion when the USB is busy. It also improves the data transfer efficiency. In the ring buffer mode, the shortest supported integration time is 1ms.

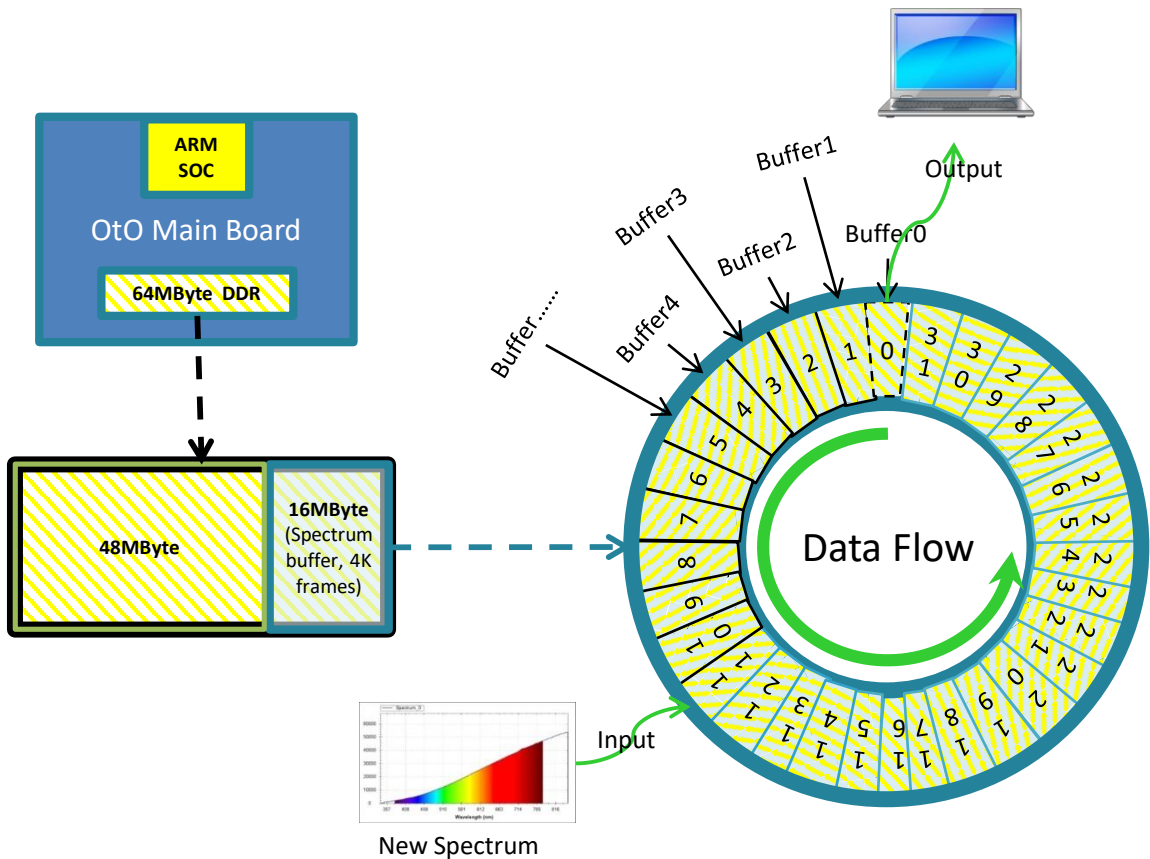

Ring buffer: 512KByte; Bulk transfer <1 sec;

16MByte stores up to 40 seconds of captured data (scanning at 100Hz)

■ USB Data Transfer and Controls

▶ Overview

The MR Series is a compact spectrometer with an embedded microcontroller and supports USB data transfer. This section provides the computer programming details on how to control the MR Series vial USB. This information is intended only for those who intend to develop their own software instead of using the standard software provided by OtO Photonics (SpectraSmart).

● Hardware Description

The MR Series leverages the built-in 32-bit RISC microcontroller in the USB 2.0 chip. The program codes and data are store in the SPI Flash. This RISC microcontroller provides 64MByte of DDR and 64Mbits of Flash.

● USB Information

MR Series USB Vendor ID: 0x0638; Product ID: 0x0AAC

The MR Series supports USB 2.0 connection and uses USB bulk streams for data transfer between the spectrometer and the computer. For more information on USB, please visit the USBIF website: <http://www.usb.org>

- **Programming Guide**

Application Programming Interface (API)

The following section provides a list of APIs and their functions.

□ **Open MR Series Spectrometer**

Description: Connecting the computer to an MR Series spectrometer.

a. Function name: UAI_SpectrometerOpen

b. Parameters:

dev: Since one computer can connect up to eight MR Series spectrometers simultaneously, the 'dev' parameter specifies which device to connect to.

handle: A unique identifier returned by the API to identify the connected spectrometer. Each connected device is assigned a different handle. This handle is used by the API to identify which device to control in subsequent operations.

□ **Get Frame Size**

Description: Getting the frame size of the sensor in the spectrometer.

a. Function name: UAI_SpectromoduleGetFrameSize

b. Parameters:

device_handle: The unique identifier for the spectrometer to be controlled.

size: Returning the frame size in 16-bit format.

□ **Acquire Wavelengths**

Description: Starting to acquire wavelengths. The MR Series can acquire the complete distribution of wavelengths.

a. Function name: UAI_SpectrometerWavelengthAcquire

b. Parameters:

device_handle: The unique identifier for the spectrometer to be controlled.

buffer: The buffer to receive the data acquired.

❑ Acquire Spectrum

Description: Starting to acquire the spectrum. The MR Series can acquire the complete spectrum corresponding to the data acquired by the "UAI_SpectrometerWavelengthAcquire" function.

a. Function name: UAI_SpectrometerDataAcquire

b. Parameters:

device_handle: The unique identifier for the spectrometer to be controlled.

integration_time_us: Specifying the integration time in 32-bit format (μ s).

buffer: The buffer to receive the data acquired.

average: The number of samples to take for signal averaging to reduce noise.

❑ Get Wavelength Range

Description: Getting the supported maximum and minimum wavelengths.

a. Function name: UAI_SpectromoduleGetWavelengthStart

UAI_SpectromoduleGetWavelengthEnd

b. Parameters:

device_handle: The unique identifier for the spectrometer to be controlled.

lambda: Returning the maximum/minimum wavelength (nm) supported by the MR Series in 32-bit format.

❑ Get Integration Time Range

Description: Getting the maximum/minimum integration time.

a. Function name: UAI_SpectromoduleGetMaximumIntegrationTime

UAI_SpectromoduleGetMinimumIntegrationTime

b. Parameters:

device_handle: The unique identifier for the spectrometer to be controlled.

Integration Time: Returning the maximum/minimum integration time supported by the MR Series in 16-bit format.

Note: The minimum integration time is specified in microseconds (μ s).
The maximum integration time is specified in thousand seconds (ks).

❑ Close MR Series Spectrometer

Description: Disconnect the computer from the MR Series spectrometer.

a. Function name: UAI_SpectrometerClose

b. Parameters:

handle: The unique identifier for the spectrometer to be disconnected. The disconnected spectrometer will stop all of its operations when this command is executed.