



FEATURES

- Wide Temperature Rating
- 2 Lead TO-39 Package
- Ideal for Hi Temp Industrial Applications
- Isolated Case
- RoHS and REACH Compliant

Electro-Optical Characteristics at 25°C

Parameters	Test Conditions	Min	Typ	Max	Units
Total Power Output, P _o	I _F = 500 mA	60	120		mW
Peak Emission Wavelength, λ _P	I _F = 50 mA		880		nm
Spectral Bandwidth at 50%, Δλ	I _F = 50 mA		55		nm
Half Intensity Beam Angle, θ	I _F = 50 mA		110		Deg
Forward Voltage, V _F	I _F = 500 mA		1.75	2	Volts
Reverse Breakdown Voltage, V _R	I _R = 10 μA	5	30		Volts
Capacitance, C	V _R = 0 V				pF
Rise Time			20		nsec
Fall Time			20		nsec

Absolute Maximum Ratings at 25°C Case

Parameters	Units
Power Dissipation ¹	1000 mW
Continuous Forward Current	500 mA
Peak Forward Current (10 μs, 200 Hz) ²	1.5 A
Reverse Voltage	5 V
Lead Soldering Temperature (1/16" from case for 10 sec)	260°C

¹ Derate per thermal derating curve above 25°C.

² Derate linearly above 25°C.

Thermal Parameters

Parameters	Units
Storage and Operating Temperature Range	-65°C to 150°C
Maximum Junction Temperature	150°C
Thermal Resistance, R _{THJA}	150°C/W Typical
Thermal Resistance, R _{THJC}	60°C/W Typical

Maximum Rated Thermal Derating Curve

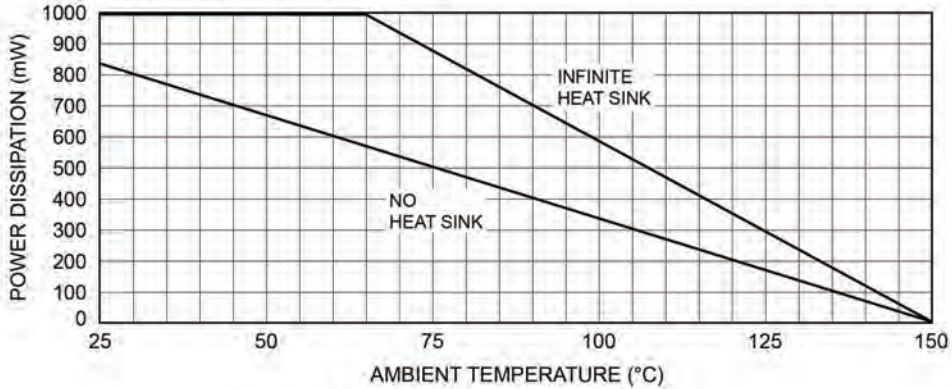

Typical Degradation Curve

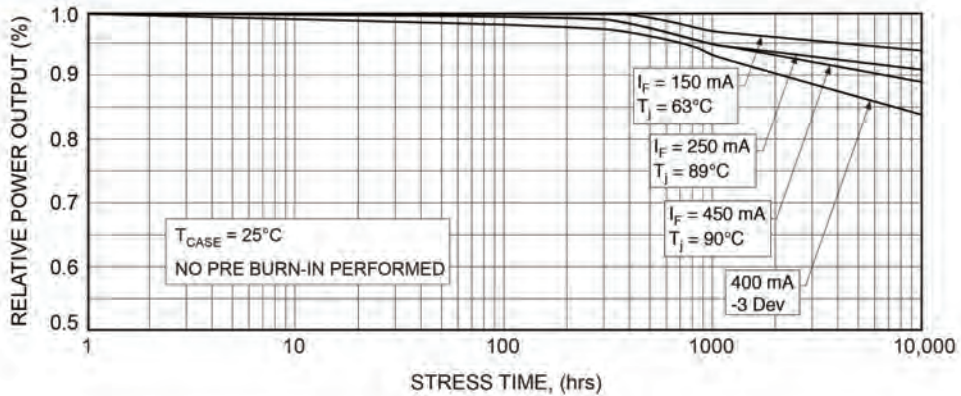

Typical Radiation Pattern

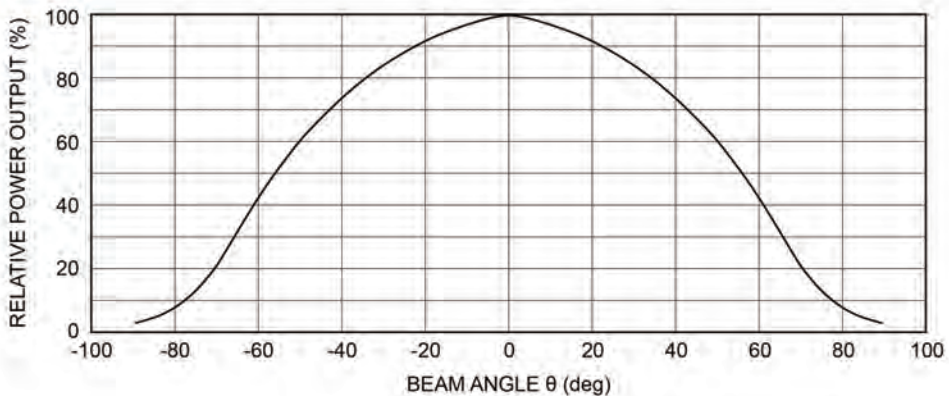

Typical Spectral Output (50 mA, Typical)

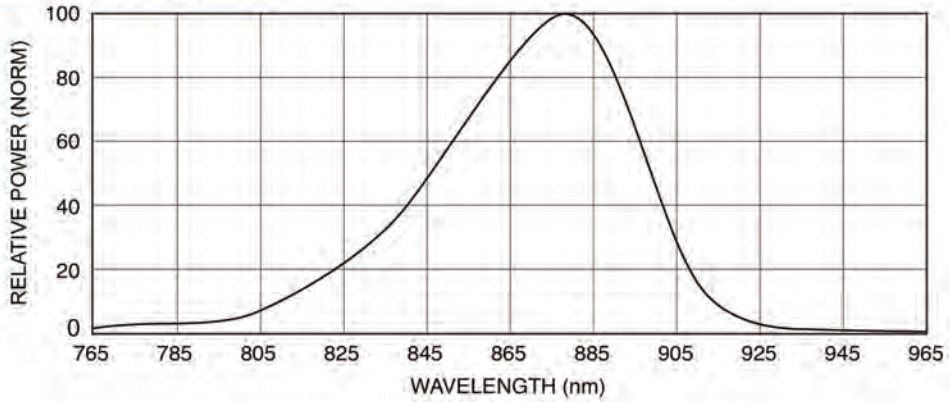

Typical Power Output vs Temperature

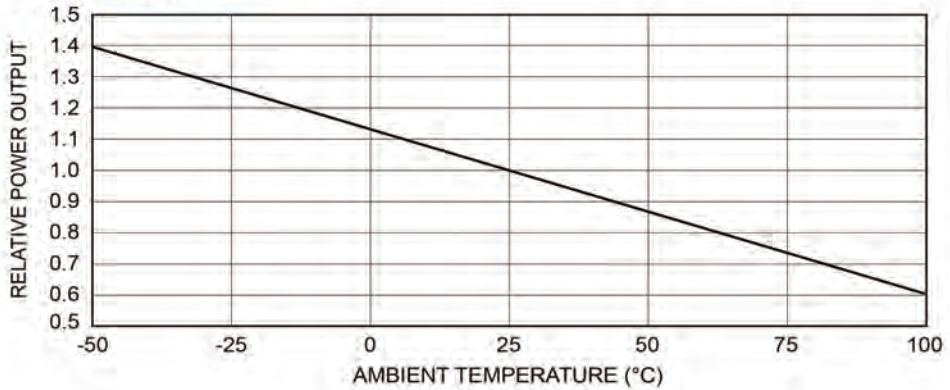

Typical Power Output vs Forward Current

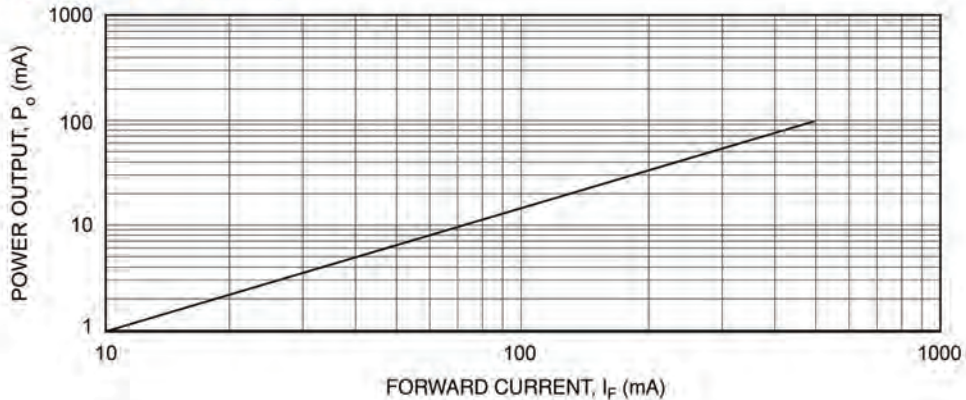

Package Information

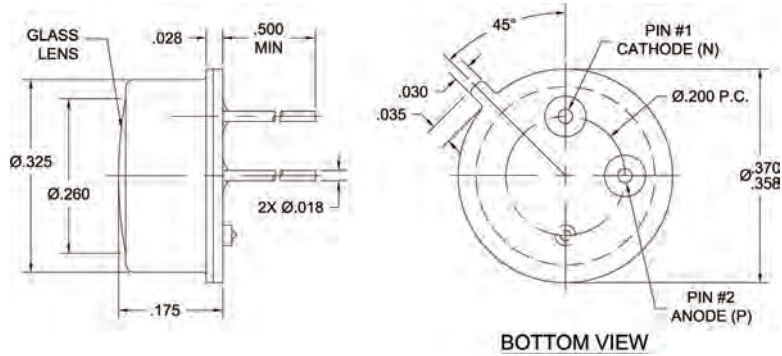

Specifications are subject to change without prior notice.

1260 Calle Suerte, Camarillo, California 93012
 Phone: +1 805.499.0335 | Fax: +1 805.499.8108 | sales@optodiode.com | www.optodiode.com