

NewDEL™ UV Fiber-coupled LED

Meticulously engineered photonic tools built to advance the goals of our customers, whether they are forging new paths in scientific discovery or implementing an ongoing project.

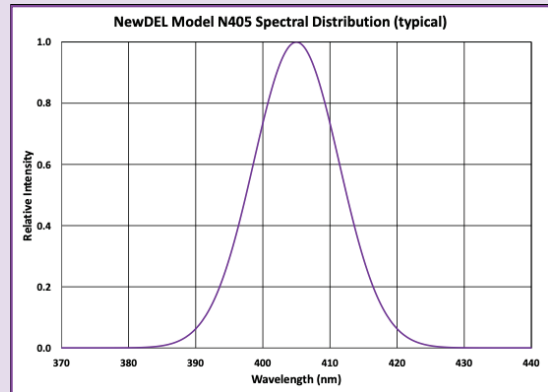

The NewDEL™ UV product group combines high performance and flexibility to serve both scientific and industrial research. Because most UV applications require increased levels of output, NewDEL™ UV are designed to deliver the highest radiant power possible from a one-millimeter diameter fiber.

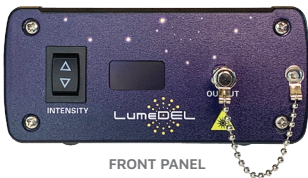

SPECIFICATIONS

- Central wavelength: **405 nm**
- FWHM: 15 nm
- Recommended fiber patch cable: Model **FP63P**, High NA Plastic Optical Fiber, NA 0.63
 - Optical power emitted (typical maximum): **240 mW**
- SMA905 connector (FC option upon request)

APPLICATIONS

- Photocuring of nanosilica filled resins
- Air and surface disinfection
- Inactivation of bacterial and fungal foodborne pathogens
- Fluorescence excitation of GFP and Alexa Fluor 405

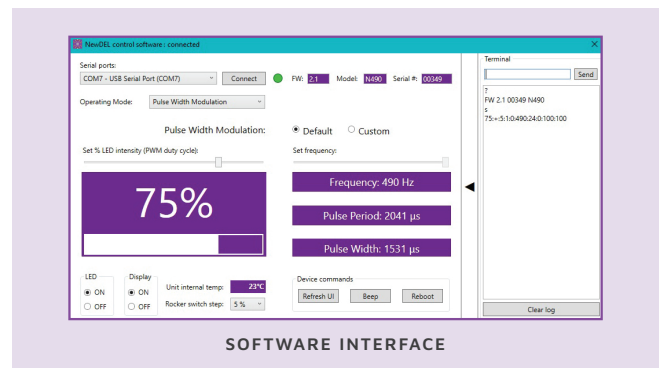

NewDEL™ Dimensions

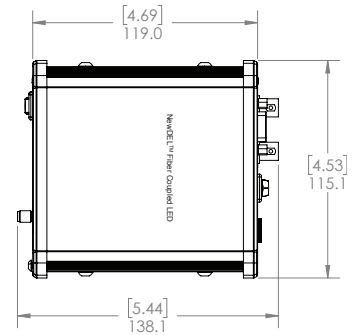
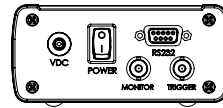
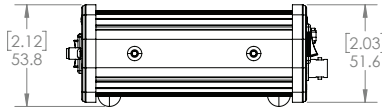
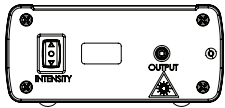

NewDEL™ Specifications

Optical coupling	SMA 905 type connector for multi-mode optical fibers with core diameters up to 1000 μm (FC connector optional)
Optical output power (typical)	240 mW
Wavelength range	405 nm
Operating modes - Pulse Width Modulation	Default 490Hz Custom (user set) 1–500Hz
Operating modes - Internal Trigger	Set Pulse Delay 10ms – 32s Set Pulse Duration 10ms – 32s
Operating modes - External Trigger	LED output controlled by 0–5V TTL
Serial Interface	RS-232, DB-9 female Converter cable RS-232 to USB-A (FTDI) is included
Trigger connector	Optically isolated BNC, 50 Ohms for External Trigger mode Cable not included
Monitor connector	BNC, 50 Ohms for reading PWM or pulse waveform Cable not included
Manual operation	Front panel intensity switch for Pulse Width Modulation mode Step size set by software; 1, 2, 4, 5, or 10 percent
Remote Operation - Software	Windows based GUI, available by download
Remote Operation - Programmability	Serial commands are provided to control a unit and query its status using a terminal program or other suitable programming systems
Front Panel Display	Passive Matrix OLED, can be deactivated through software % PWM Intensity or trigger operating mode with frequency
Thermal management	Passive cooling via conduction Internal temperature sensor/monitor readable by software
Power supply	Universal AC/DC Wall adapter, 90 to 264VAC at 47 to 63Hz input 12V 12W output, 1.5 m cord length, DOE VI Efficiency, Class B EMI, Safety Approvals: cUL/UL, RCM, CB, CE (international socket blade options)
Dimensions/Weight	4.7 x 4.5 x 2.0 in (119.1 x 115.1 x 51.6 mm) / 1.1 lbs (0.5 kg)

Peripherals & Accessories

