

PEVAL-KIT-MCX

Evaluation Kit for Optical Bench Mount



Key Features Overview

- Plug and Play for any KETEK SiPM on Pin Socket
- Optical bench mount compatible with Thorlabs®
- Including Preamplifier and Cables
- AC or DC coupled readout PCBs available
- Easy Integration to Optical Bench Setups
- Optional SiPM Bias Source available

Introduction and Specification Overview

The KETEK SiPM Evaluation Kit allows an easy operation and evaluation of any KETEK SiPM. It can be used for a wide range of applications which require e.g. single photon counting or measurements with scintillators. Two of the evaluation kits can be mounted face to face for coincidence measurements. The evaluation kit PCBs are equipped with a pin socket for easy exchange of the SiPM. For its operation a +12 V DC power supply, a bias source and e.g. an oscilloscope are required.

Fig. 1 – 3 and tab. 1 show an overview of the evaluation kit and the two different available readout PCBs that are preassembled in Thorlabs® CP02/M 30 mm optomechanical cage plates. For full technical specifications of all products, please refer to www.ketek.net/sipm-downloads

Fig. 1
PEVAL-KIT-MCX Connection Scheme



CP02/M cage plate included, 30 mm system, 40.6 x 40.6 x 8.9 mm³, <https://www.thorlabs.com/thorproduct.cfm?partnumber=CP02/M>
 3 MCX to SMA cables included, <https://www.ketek.net/store/products/mcx-sma-cable/>

Note: Thorlabs® optical post assembly for reference only and not included in the evaluation kit

Preamplifier Specifications

Parameter	Unit
Low Noise	2.9 dB typ.
Frequency Range	0.1 to 1000 MHz
Intrinsic time jitter	20 ps FWHM
Gain	13
DC supply voltage	+12 V DC
Supply current	Max. 100 mA
SMA connectors	Signal in, signal out
Dimensions	31.75 x 31.75 x 19.05 mm ³

PEVAL-KIT-MCX Evaluation Kit for Optical Bench Mount

Fig. 2
 PEPCB-EVAL-MCX-RES-P Connection Scheme

A.
 Anode

C
 Cathode

Pin Socket:
 Preci-Dip
 801-87-003-10-001101



BIAS+
 Positive Bias

SIGNAL
 Signal Out
 (DC coupled,
 51 Ω load)

MCX connectors

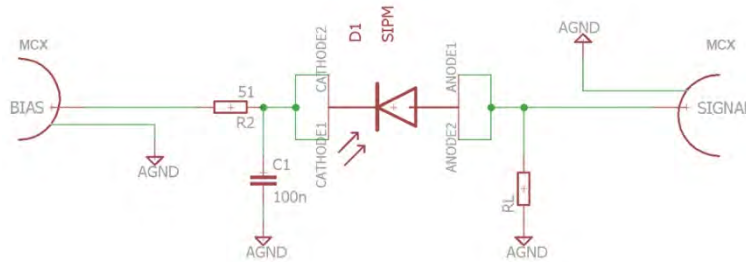

Fig. 3
 PEPCB-EVAL-MCX-P Connection Scheme

A.
 Anode

C
 Cathode

Pin Socket:
 Preci-Dip
 801-87-003-10-001101



BIAS+
 Positive Bias

SIGNAL
 Signal Out
 (AC coupled, 90%)

Monitor
 Monitor Out
 (AC coupled, 10%)

MCX connectors

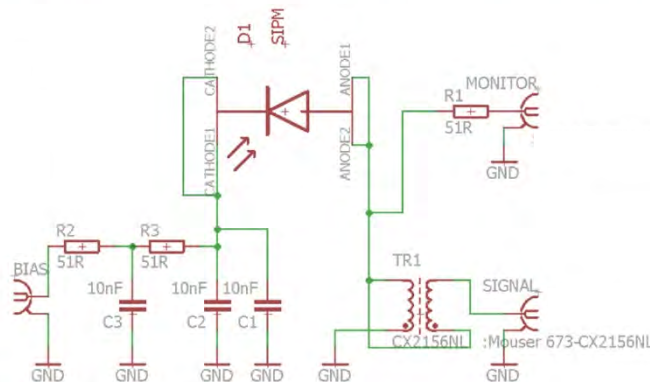

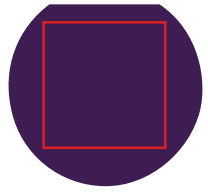

PEVAL-KIT-MCX

Evaluation Kit for Optical Bench Mount

KETEK

Setup Example

- All sockets on the PEPCB-EVAL-MCX are MCX type that are converted to SMA type with the cables (PECABLE) included in the evaluation kit. The preamplifier is equipped with solder pins for power but clamps may also be used (c.f. fig. 1). Signal lines need to be terminated with 50 Ω .
- Preamplifier power: +12V DC, 150 mA
- BIAS+: positive with max. + 40 V, typical current limit 2 mA is recommended
- DC coupled PEPCB-EVAL-MCX-RES-P
 - 51 Ω load resistor (RL) pre-soldered to the PCB
 - SIGNAL: either connected to the preamplifier (recommended for low light levels or single photon counting) or directly connected e.g. to an oscilloscope using 50 Ω termination (resulting in an effective load of 25.5 Ω , since in parallel to the 51 Ω RL).
- AC coupled PEPCB-EVAL-MCX -P
- A Balun reference transformer is included on the PCB for impedance matching and best achievable timing on the SIGNAL output
 - Includes a 90/10 split on the PEPCB-EVAL-MCX -P
 - SIGNAL: 90% of the initial SiPM signal
 - MONITOR: 10% of the initial SiPM signal
 - Application example measuring time information and charge simultaneously
 - SIGNAL connected to the preamplifier, using this path for timing measurements
 - MONITOR path used e.g. for charge integration
- Since the SiPM is a highly sensitive photodetector, it must be operated under dark conditions.
- After biasing the SiPM with e.g. the recommended bias voltage (5 V above the breakdown voltage), dark counts should be visible at the amplified SIGNAL path, using e.g. an oscilloscope set to a time base of 100 ns/div and a vertical resolution of 20 mV/div.
- *Note: The procedure may vary depending on the used readout electronics. For the examples shown here, a digital oscilloscope is used.*

Dark Count Spectrum

- All sockets on the PEPCB-EVAL-MCX are MCX type that are converted to SMA type with the cables included in the At the oscilloscope, set the trigger to the amplified SiPM signal at 0.5 pe amplitude (1 pe is the smallest occurring pulse height, corresponding to a photoelectron pe).
- *Note: This measurement has to be done under dark conditions without illuminating the SiPM.*
- Measure the area respectively the charge of the signal at the position of the trigger point in e.g. a 25 ns wide gate. Best results are obtained by integrating the whole positive pulse area.
- Histogramming of the integrated charge is the resulting dark count spectrum.
- *Note: E.g. crosstalk probability can be extracted from the dark count spectrum.*

Single Photon Spectrum

- For this measurement, a pulsed light source is needed. This can be e.g. a pulsed LED or a pulsed laser. Connect the electrical trigger output of the pulser to the oscilloscope (e.g. ch1) and set the trigger to it.
- Note: In case a synchronized electrical trigger output is not provided by the pulser, a second SiPM Evaluation Kit can be used to generate the trigger signal. This second SiPM should be fully illuminated by the same optical pulse e.g. with an optical beam splitter. The other path for the single photon measurement can be attenuated e.g. with neutral density filters.
- Measure the area respectively the charge of the SiPM signal in e.g. a 25 ns wide gate. The histogram of the measured charge is the single photon spectrum (cf. fig. 4).
- *Note: E.g. the relative gain, breakdown voltage and photo detection efficiency can be extracted. Please also refer to <https://www.ketek.net/sipm/technology/device-parameters/>*

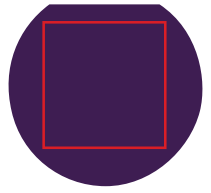

PEVAL-KIT-MCX

Evaluation Kit for Optical Bench Mount

Fig. 4
 Example of a Single Photon Spectrum

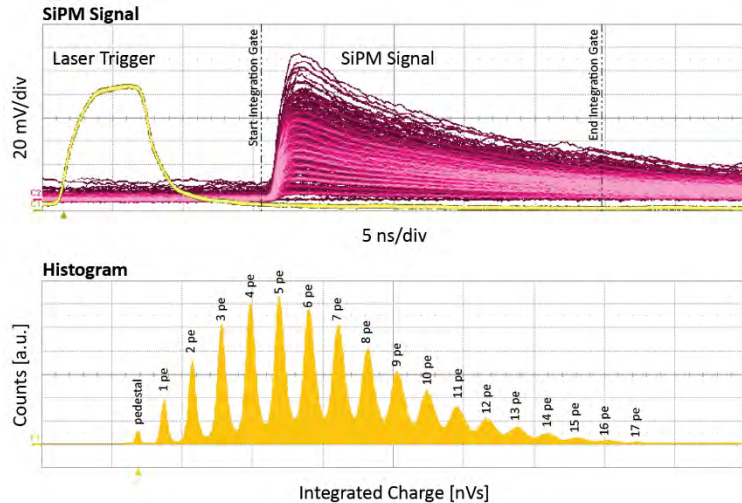

Using the Full Dynamic Range

- The amplified SiPM signal output and the Monitor output can be connected and used simultaneously. Typically for low light levels down to single photons, the measurement is done with the amplified output. For higher light levels, the preamplifier will saturate at 0.5 V signal amplitude. After this point, the MONITOR output is measured. This allows to make use of the the full dynamic range of the SiPM.

Measurements with Scintillator

- With bright scintillators typically the charge released by the SiPM exceeds the dynamic range of the preamplifier. In this case, either the SIGNAL can be measured without using the preamplifier or the MONITOR output is used. The charge released by the SiPM is a measure for the detected number of scintillating photons and thus a measure for the deposited energy in the scintillator.
- For simultaneous measurements of timing and energy, the amplified SIGNAL is used for timing and the MONITOR output for the energy measurement.
- Note: Even though the preamplifier may be in saturation, timing can still be measured at the steep rising edge of the amplified SIGNAL close to the baseline.*
- Usually the monitor output is used to measure the charge released by the SiPM corresponding to the deposited energy in the scintillator.

Energy Spectrum

- In analogy to section 3.1, at the oscilloscope the trigger has to be set to the SiPM signal above the baseline and the pulse area as a measure for the energy is histogrammed.
- Fig. 5 shows an example energy spectrum of a ^{22}Na source measured with the Monitor output. The used scintillator is LYSO wrapped in PTFE as reflector and with a size of $3 \times 3 \times 5 \text{ mm}^3$. The used coupling material is Dow Corning® 1-2577 conformal coating.

Coincidence Time Resolution

- Two Evaluation Kits are mounted facing each other
 - Note: Thorlabs® optomechanical 30 mm cage components can be used for easy mounting.
- The example (c.f. fig. 6) uses two SiPMs, each with $3.0 \times 3.0 \times 5.0 \text{ mm}^3$ LYSO and ^{22}Na as radioactive source.
 - Note: ^{22}Na has two decay branches. It emits two 511 keV annihilation γ rays in opposing directions, originating from a β decay. The second decay emits a single 1.27 MeV γ ray. Of interest here are the two 511 keV γ rays for the coincidence measurement.
- MONITOR outputs are connected to a coincidence logic, e.g. realized by the oscilloscope, to filter the energy
 - Lower threshold of the coincidence logic defines the lower energy cut-off. The thresholds for both MONITOR outputs are set to the minimum between Compton edge and 511 keV photopeak to filter for the energy respectively coincident events.
- The output of the coincidence logic triggers the measurement of the time stamps of both amplified SIGNAL outputs.
 - Note: Best timing is achieved with a timing measurement close to the baseline. Typically with LYSO the optimum is around 2 - 3 pe.

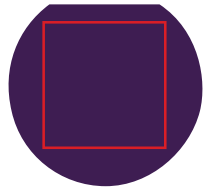

PEVAL-KIT-MCX Evaluation Kit for Optical Bench Mount

- The time stamps of both amplified SIGNAL outputs can be measured e.g. with a leading edge discriminator, a constant fraction discriminator or by using the measurement functions of an oscilloscope.
- The time difference between both time stamps is then histogrammed (c.f. fig. 6). The coincidence time resolution (CTR) corresponds to the FWHM of the Gaussian distribution.

Fig. 5
 Example of an Energy Spectrum of ^{22}Na and LYSO $3 \times 3 \times 5 \text{ mm}^3$

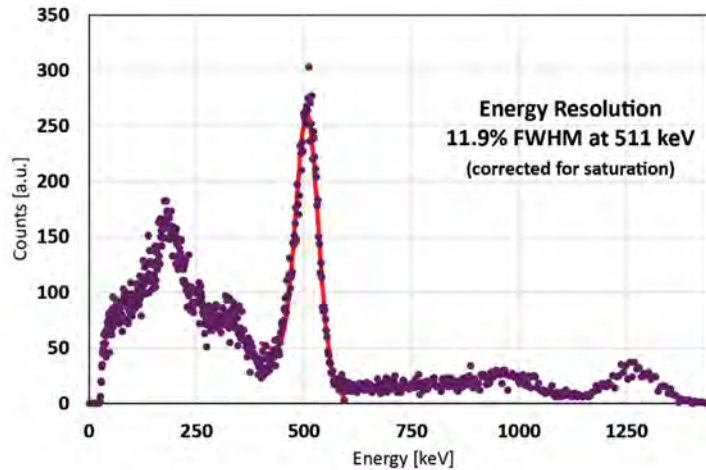
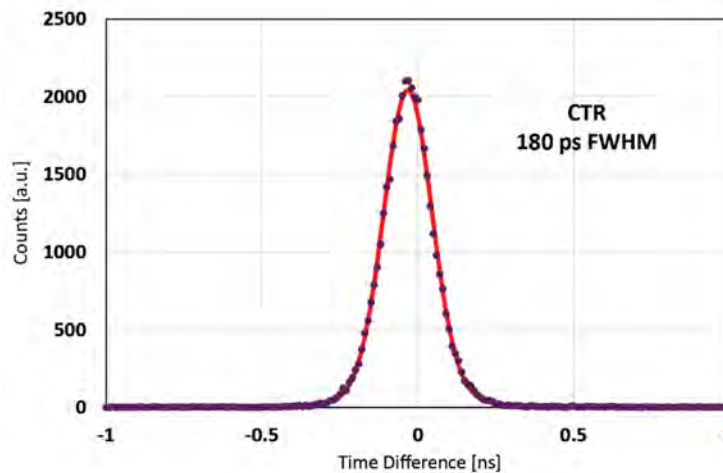

Fig. 6
 Example of a Coincidence Time Resolution Histogram measured with ^{22}Na and LYSO $3 \times 3 \times 5 \text{ mm}^3$



Optical Bench Mount Components

- Further optomechanical components for easy integration of the evaluation kit to existing optical bench setups are available from Thorlabs®
<https://www.thorlabs.com/>

SiPM Bias Source

- As an add-on to the evaluation kits, a SiPM Bias Source is available to purchase (c.f. fig. 1). It offers an adjustable bias voltage from 20 to 40 V with either positive or negative polarity. Current limit can be set to either 2 or 20 mA. It can be directly purchased from our web store:
<https://www.ketek.net/store/products/sipm-bias-source/>
 For full technical specifications please refer to the KETEK SiPM Bias Source Datasheet:

Quick Start Guide

SiPM – Silicon Photomultiplier

PEVAL-KIT-MCX

Evaluation Kit for Optical Bench Mount

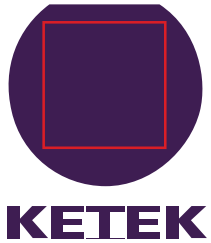

SiPM Webshop

- Evaluation kits, additional SiPMs, PCBs and accessories are available for purchase from our web store: <https://www.ketek.net/store/>



Caution

This product is intended for evaluation purposes only. Therefore it is to be handled only by trained personnel in a laboratory environment.

Revision History

Revision and Date	Changes
Rev. 2020-B April 2020	Updated design and layout
Rev. 2020-A January 2020	Removed version of evaluation kit with outdated form factor (PEVAL-KIT-SMA) Updated "Fig. 1 PEVAL-KIT-MCX Connection Scheme" Added "Preamplifier Specifications" table Added overview "Fig. 2 PEPCB-EVAL-MCX-RES-P Connection Scheme" Added overview "Fig. 3 PEPCB-EVAL-MCX-P Connection Scheme" Text reformulations Added "Appendix" with links to corresponding products
Rev. 2016-A August 2016	Initial Release

Important Notice

KETEK reserves the right to make changes without further notice to any products herein. KETEK makes no warranty, representation or guarantee regarding the suitability of its products for any particular purpose, nor does KETEK assume any liability arising out of the application or use of any product or circuit, and specifically disclaims any and all liability, including without limitation special, consequential or incidental damages. "Typical" parameters which may be provided in KETEK data sheets and/or specifications can and do vary in different applications and actual performance may vary over time. All operating parameters, including "Typical" must be validated for each customer application by customer's technical experts. KETEK does not convey any license under its patent rights nor the rights of others. KETEK products are not designed, intended, or authorized for use as components in applications in which the failure of the KETEK product could create a situation where personal injury or death may occur. Should Buyer purchase or use KETEK products for any such unintended or unauthorized application, Buyer shall indemnify and hold KETEK and its officers, employees, subsidiaries, affiliates, and distributors harmless against all claims, costs, damages, and expenses, and reasonable attorney fees arising out of, directly or indirectly, any claim of personal injury or death associated with such unintended or unauthorized use, even if such claim alleges that KETEK was negligent regarding the design or manufacture of the part.