

AFBR-S4N66P014M

NUV-MT Silicon Photomultiplier

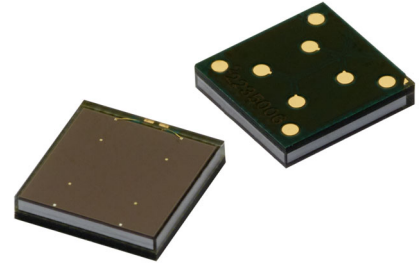

Description

The Broadcom[®] AFBR-S4N66P014M is single-channel silicon photomultiplier (SiPM) that is used for ultra-sensitive precision measurements of single photons. This SiPM is based on the NUV-MT technology, which combines improved photo-detection efficiency (PDE) with a decreased dark count rate and reduced crosstalk compared to the NUV-HD technology. The SPAD pitch is 40 μm .

Larger areas can be covered by tiling multiple AFBR-S4N66P014M SiPMs. The encapsulation for good mechanical stability and robustness is realized by an epoxy clear mold compound, which is highly transparent down to UV wavelengths, resulting in a broad response in the visible light spectrum with high sensitivity toward the blue and near-UV region of the light spectrum. The SiPM is best suited for the detection of low-level pulsed light sources, especially for detection of Cherenkov or scintillation light from the most common organic (plastic) and inorganic scintillator materials (for example, LSO, LYSO, BGO, NaI, CsI, BaF, LaBr₃). This product is lead-free and compliant with RoHS.

Features

- High PDE (63% at 420 nm)
- 4-side tileable, with high fill factors
- Cell pitch: 40 μm
- Highly transparent epoxy protection layer
- Operating temperature range from -20°C to $+60^{\circ}\text{C}$
- Excellent SPTR and CRT
- Excellent uniformity of breakdown voltage and gain between devices
- RoHS, CFM, and REACH compliant

Applications

- X-ray and gamma-ray detection
- Nuclear medicine
- Positron emission tomography
- Safety and security
- Physics experiments
- Cherenkov detection

Block Diagram

Figure 1: AFBR-S4N66P014M Block Diagram

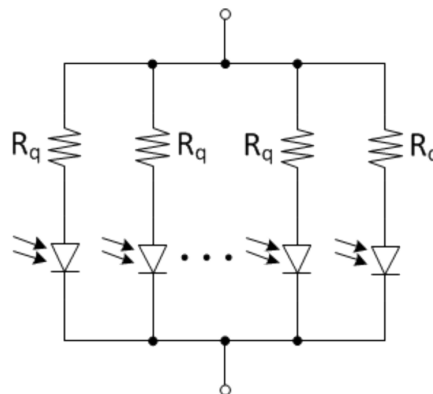

Pad Layout

The AFBR-S4N66P014M has four anode pads and four cathode pads. The pad layout is displayed in the following figure.

Figure 2: Pad Layout

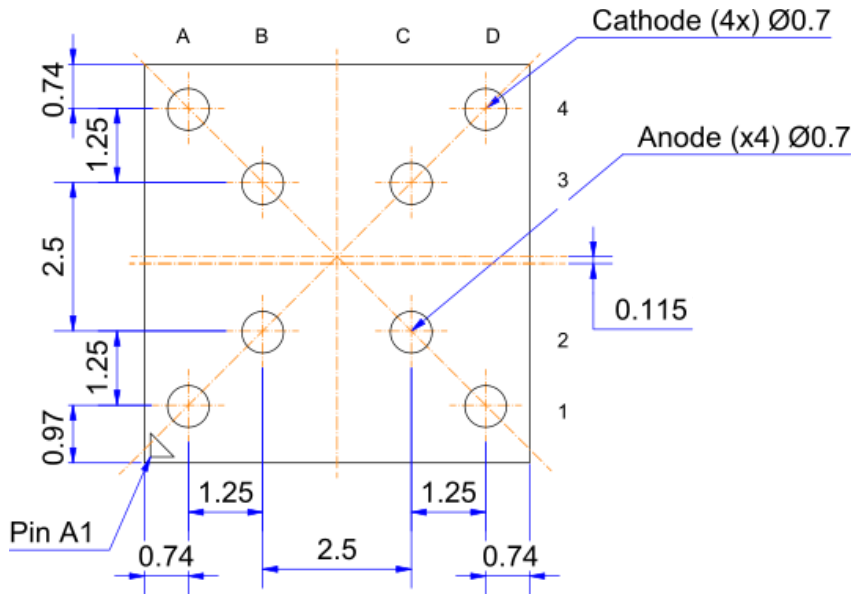

| Pad | Function |
|-------------|----------|
| A1,A4,D1,D4 | Cathode |
| B2,B3,C2,C3 | Anode |

NOTE: Dimensions are in mm.

Figure 3: Recommended Landing Pattern

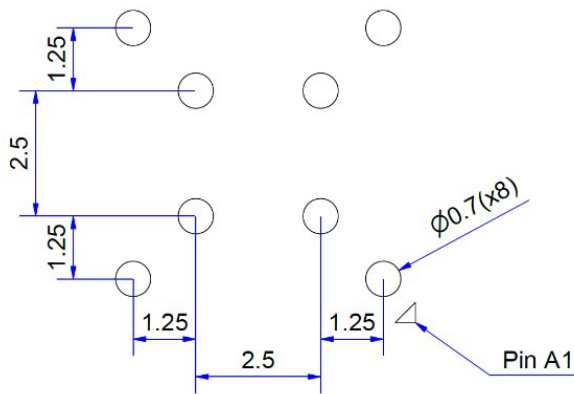

NOTE: The center of the active SiPM area is not the center of the footprint. See Figure 12 for details.

Regulatory Compliance Table

| Feature | Test Method | Performance |
|--|------------------------------------|--|
| Electrostatic discharge (ESD) to the electrical pins, human-body model (contact ESD) | JESD22-A114 | See Absolute Maximum Ratings . |
| Electrostatic discharge (ESD) to the electrical pins, charged-device model | JESD22-C101F | See Absolute Maximum Ratings . |
| Restriction of hazardous substances directive | RoHS Directive 2011/65/EU Annex II | Certified compliant. |

Reflow Soldering Diagram

Figure 4: Recommended Reflow Soldering Profile

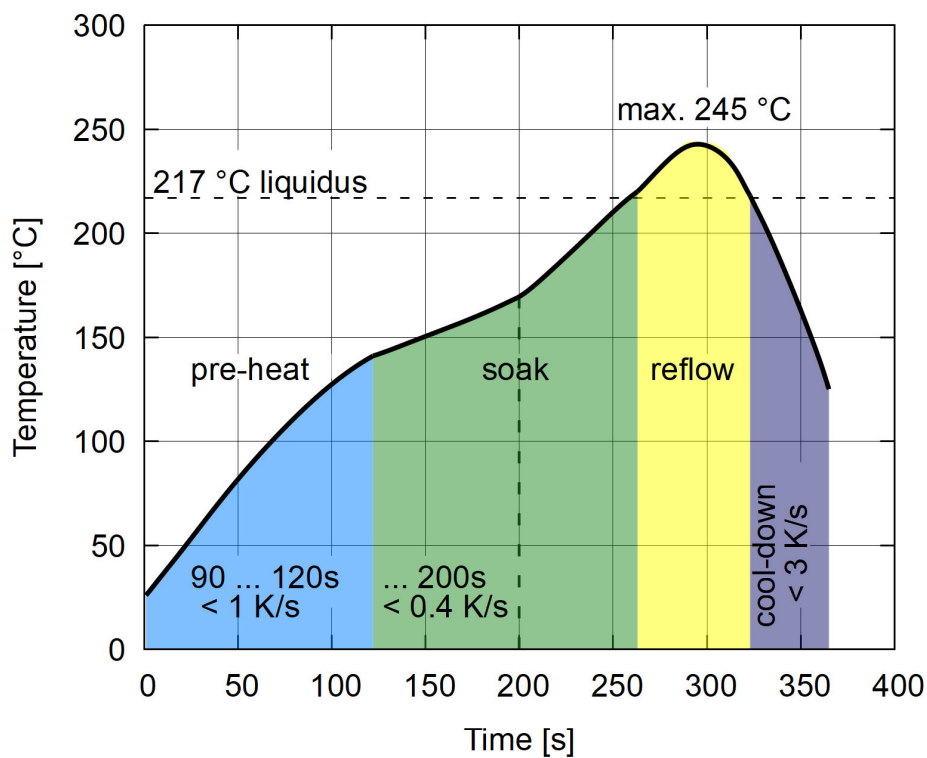

Absolute Maximum Ratings

Stresses in excess of the absolute maximum ratings can cause damage to the devices. Limits apply to each parameter in isolation. Absolute maximum ratings are those values beyond which damage to the device may occur if these limits are exceeded for other than a short period of time.

| Parameter | Symbol | Min. | Max. | Unit |
|--|-------------|------|------|------|
| Storage Temperature | T_{SG} | -20 | +60 | °C |
| Operating Temperature ^a | T_A | -20 | +60 | °C |
| Soldering Temperature ^{b,c} | T_{SOLD} | — | 245 | °C |
| Lead Soldering Time ^{b,c} | t_{SOLD} | — | 60 | s |
| Electrostatic Discharge Voltage Capability (HBM) | ESD_{HBM} | — | 2 | kV |
| Electrostatic Discharge Voltage Capability (CDM) | ESD_{CDM} | — | 500 | V |
| Operating Overvoltage | V_{OV} | — | 16 | V |

- Biased at constant voltage = 12V above breakdown.
- The tile is reflow solderable according to the solder diagram shown in [Figure 4](#).
- In accordance with Broadcom's PCN-272931, there will be a transition in the moisture level definition (MLD) for the NUV-MT SiPM series from MSL 6 to MSL 5. Refer to the label of your devices for details on the MLD. For parts in accordance with MSL 6, baking at 125°C for 16 hours is mandatory before soldering. The floor life is 4 hours at 30°C and 60% relative humidity. For parts with an MLD according to MSL 5, the floor life is 48 hours at 30°C and 60% relative humidity. No baking is required before soldering unless the floor life is exceeded. For more details on soldering and handling, refer to Broadcom's application note [AFBR-S4NxxPyy4M-AN602](#).

Single Device Specification

Features are measured at 25°C unless otherwise specified.

Geometric Features

| Parameter | Symbol | Value | Unit |
|-----------------------------------|-------------|-------------|-----------------|
| Package outer dimensions | PD | 6.48 x 6.71 | mm ² |
| Single device area | DA | 6.14 x 6.14 | mm ² |
| Active area | AA | 6.00 x 6.00 | mm ² |
| Micro cell pitch | L_{CELL} | 40 | µm |
| Number of micro cells per element | N_{CELLS} | 22,428 | — |

Optical and Electrical Features

Features are measured at 12V OV and 25°C unless otherwise specified.

| Parameter | Symbol | Min. | Typical ^a | Max. | Unit | Reference Plots |
|--|--------------------------|------|----------------------|------|------------------------|---|
| Spectral range | λ | 250 | — | 900 | nm | Figure 5 |
| Peak sensitivity wavelength | λ_{PK} | — | 420 | — | nm | Figure 5 |
| Breakdown voltage | V_{BD} | 32 | 32.5 | 33 | V | Figure 7 |
| Temperature coefficient of breakdown voltage | $\Delta V_{BD}/\Delta T$ | — | 30 | — | mV/°C | — |
| Photo-detection efficiency ^b | PDE | — | 63 | — | % | Figure 5 , Figure 6 |
| Dark current per element | I_D | — | 8.6 | — | μA | Figure 7 |
| Dark count rate per element ^c | DCR | — | 4.4 | — | Mcps | Figure 8 |
| Dark count rate per unit area | DCR_{mm^2} | — | 125 | — | kcps/mm ² | — |
| Gain | G | — | 7.3 | — | $\times 10^6$ | Figure 9 |
| Optical crosstalk | P_{XTALK} | — | 23 | — | % | Figure 10 |
| Afterpulsing probability | P_{AD} | — | < 1 | — | % | Figure 10 |
| Recharge time constant | T_{FALL} | — | 55 | — | ns | Figure 11 |
| Nominal terminal capacitance ^d | C_T | — | 1550 | — | pF | — |
| Temperature coefficient of gain ^e | $\Delta G/\Delta T$ | — | 1.46 | — | $\times 10^4/^\circ C$ | — |

a. Measured at 12V OV.

b. Measured at the peak sensitivity wavelength. Measurement does not include correlated noise, such as afterpulsing or optical crosstalk.

c. Measured at 0.5 p.e. amplitude. Measurement does not include delayed correlated events.

d. Measured using the input sine wave with $f = 200$ kHz and $V_{in} = 500$ mV.

e. Calculated from the gain dependence on V and the breakdown voltage temperature coefficient: $dG/dT = dG/dV \times dVBD/dT$.

Reference Plots

Features are measured at 25°C unless otherwise specified. Plotted data represents typical values.

Figure 5: PDE vs. Wavelength

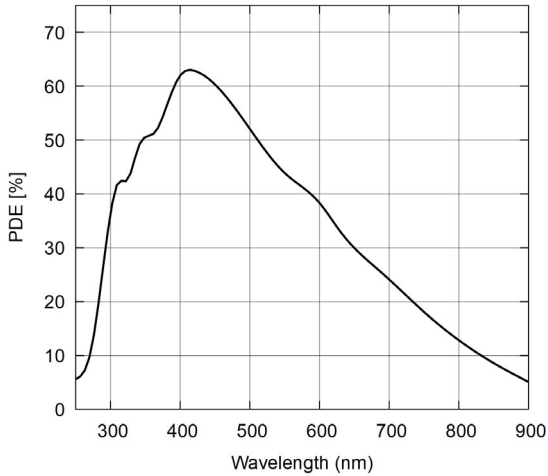

Figure 6: PDE at Peak λ vs. OV

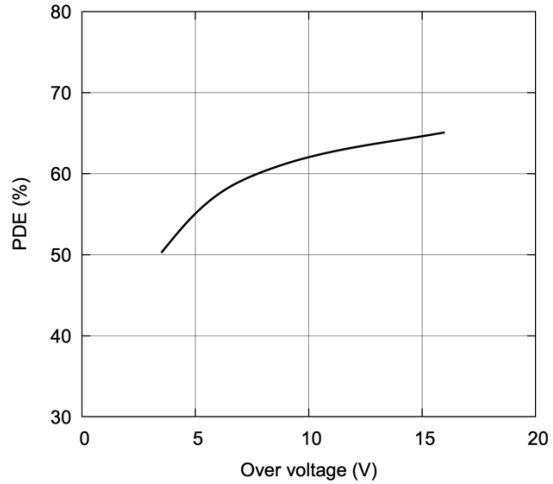

Figure 7: Reverse IV Curve

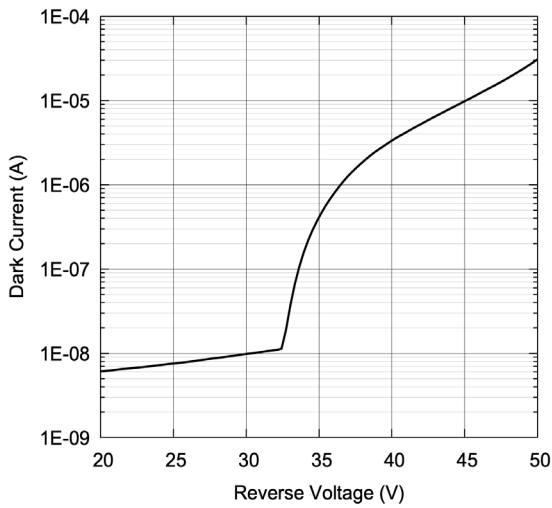

Figure 8: Dark Count Rate vs. OV

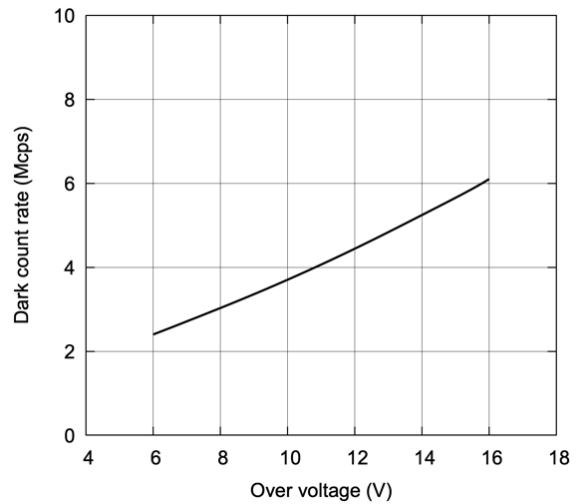

Figure 9: Gain vs. OV

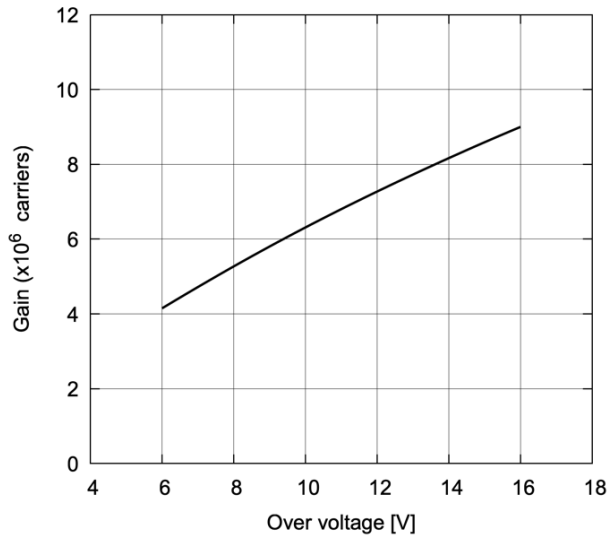

Figure 10: Correlated Noise vs. OV

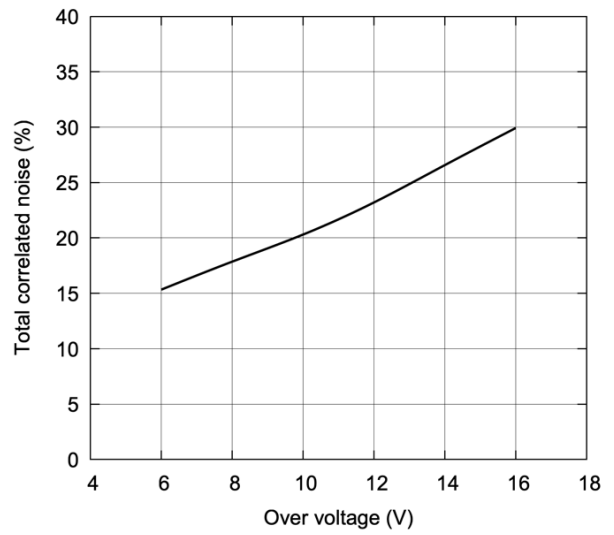
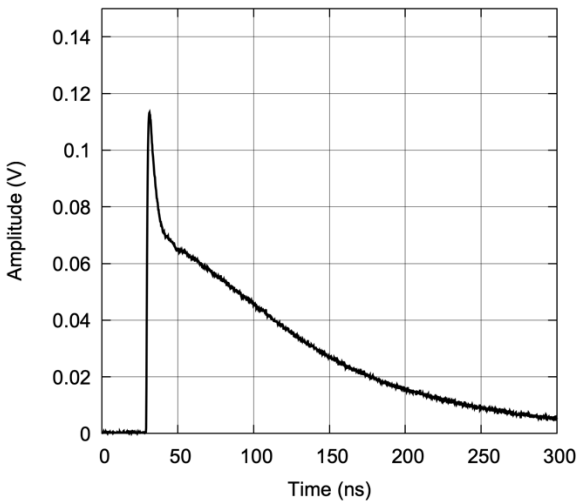
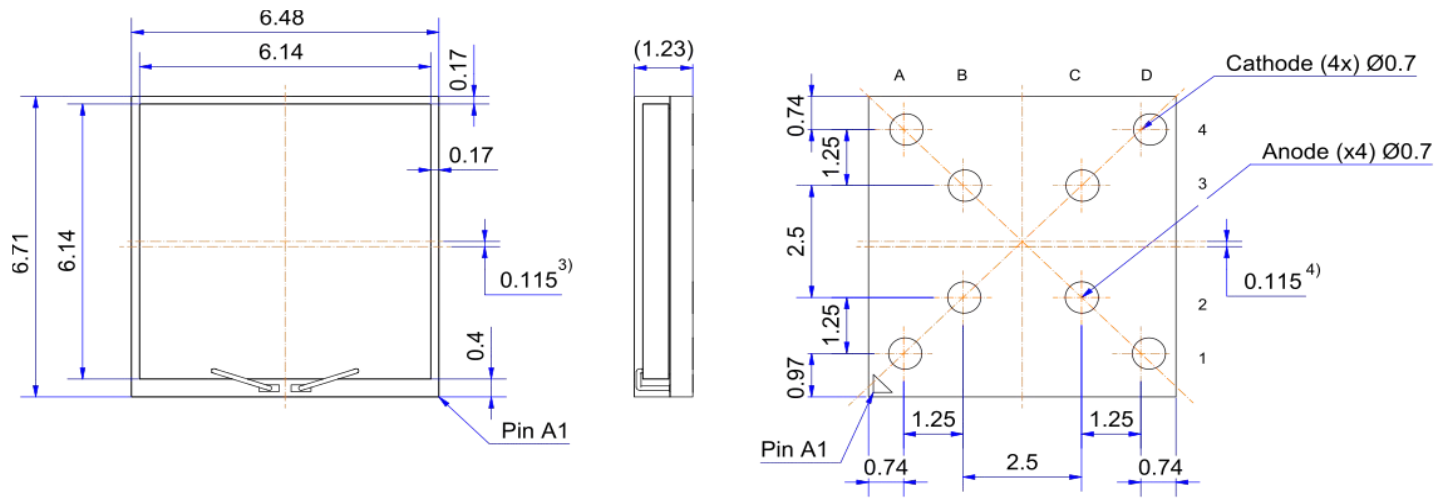

Figure 11: Example Signal Measured at 12V OV



Mechanical Data – Package Outline

Figure 12: Package Outline Drawing (Dimensions in mm, Numbers Rounded to Two Decimal Places)



NOTES

- 1) Dimensions are in millimeters.
- 2) Nominal values rounded to two decimal places - Suppression of following zeros
- 3) Distance from chip center to package center
- 4) Distance pad geometry to package center

Copyright © 2022–2024 Broadcom. All Rights Reserved. The term “Broadcom” refers to Broadcom Inc. and/or its subsidiaries. For more information, go to www.broadcom.com. All trademarks, trade names, service marks, and logos referenced herein belong to their respective companies.

Broadcom reserves the right to make changes without further notice to any products or data herein to improve reliability, function, or design. Information furnished by Broadcom is believed to be accurate and reliable. However, Broadcom does not assume any liability arising out of the application or use of this information, nor the application or use of any product or circuit described herein, neither does it convey any license under its patent rights nor the rights of others.

